



# Vivekanand Education Society's Institute of Technology

Since 1962

(Affiliated to University of Mumbai, Approved by AICTE & Recognized by Govt. of Maharashtra)

## Criteria 3- Research, Innovations and Extension

### Key Indicator 3.1- Resource Mobilization for Research

#### 3.1.3 - Percentage of departments having Research projects funded by government and non government agencies during the last five years

#### DVV Query:

Provide grant award letter of teachers along with the department affiliation, title of the funded project, the amount and the funding agency during the year 2016-17, 2017-18, 2018-19 and 2019-20, 2020-21.

#### INDEX

Sr No	Name of Project //	Name of the Principal Investigator	Department	Pg No
1	<b>Swachhha Project</b> 2020-21 Rs.2400000 Star Union Dai-chi Life Insurance Co Ltd	Dr.(Ms).Vijayalakshmi M Dr.(Ms) Shanta Sondur	<b>Information Technology</b>	<a href="#">10</a>
2	<b>Monitoring and Assessing Coral Reefs in Oceans(Compute Grant)</b> 2020-21 Rs.350000 AI for Earth Microsoft Azure Compute Grant	Ms. Mannat Doutlani Ms.Abha Tiwari	<b>Computer Engineering</b>	<a href="#">30</a>
3	<b>Artificial Intelligence Model for Epidemiology of Tuberculosis</b> 2020-21 Rs.30000 The Tuberculosis Association of India - Short Term Research Projects : Financial Assistance Scheme	Dr.(Ms)Nupur Giri	<b>Computer Engineering</b>	<a href="#">31</a>
4	<b>Forest Fire Prediction Using LSTM Networks</b> 2020-21 Rs.1170000 AI for Earth Microsoft Azure Compute Grant	Ms. Sukanya Roychowdhury	<b>Information Technology</b>	<a href="#">34</a>
5	<b>Land Use Classification Using Satellite Images(Compute Grant)</b> 2020-21 Rs.1170000 AI for Earth Microsoft Azure Compute Grant	Ms. Jayashree Hajgude	<b>Information Technology</b>	<a href="#">35</a>



# Vivekanand Education Society's Institute of Technology

(Affiliated to University of Mumbai, Approved by AICTE & Recognized by Govt. of Maharashtra)

6	<b>AI based Farmer Empowerment (Compute Grant)</b> 2020-21 Rs.780000 AI for Earth Microsoft Azure Compute Grant	Dr (Ms) M. Vijayalakshmi	Information Technology	<a href="#">37</a>
7	<b>Calibration for Nuclear Spectroscopy Application</b> 2020-21 Rs.100000 MHRD	Ms.Asma Parveen	Information Technology	<a href="#">38</a>
8	<b>High Resolution Multichannel Analyzer for nuclear spectroscopy application</b> 2020-21 Rs.100000 MHRD	Mr.Gopalakrishnan.N Ms.Ajesh Lekshmi	Instrumentation Engineering	<a href="#">38</a>
9	<b>Swadeshi Battery Management Systems</b> 2020-21 Rs.100000 MHRD	Mr.Mrugendra Vasmatkar	Electronics & Telecommunication Engineering	<a href="#">38</a>
10	<b>"Drowsiness detecting Wearable for Heavy Machinery Operators</b> 2020-21 Rs.20000 IICDC Conclave , DST & Texas Instruments (TI) Inc	Ms.Sangeeta Prassanaram	Instrumentation Engineering	<a href="#">41</a>
11	<b>Development of Methodology for Indian Evaluated Nuclear Data Library for applications in S &amp; T (Compute Grant)</b> 2019-2020 Rs.1781276 DAE-BRNS	Dr.(Ms.)Jayalekshmi M Nair Ms. Sangeetha P. Ram	Instrumentation Engineering	<a href="#">43</a>
12	<b>Multi-Functional Detachable Applications For Drones</b> 2019-2020 Rs.20000 IICDC Conclave , DST & Texas Instruments (TI) Inc	Mr.Mrugendra Vasmatkar	Electronics & Telecommunication Engineering	<a href="#">47</a>
13	<b>Adoption of Artificial Intelligence in agriculture (Compute Grant)</b> 2019-2020 Rs.780000 Microsoft	Dr. (Ms.) M.Vijayalakshmi Dr Shalu Chopra	Information Technology	<a href="#">49</a>
14	<b>Cost effective electronic limbs</b> 2019-2020 Rs.45000 University of Mumbai Minor Research Grant Project Research Grant Project	Ms. Nusarat Ansari	Electronics & Telecommunication Engineering	<a href="#">50</a>



# Vivekanand Education Society's Institute of Technology

(Affiliated to University of Mumbai, Approved by AICTE & Recognized by Govt. of Maharashtra)

15	<b>Agri Robot</b> 2019-2020 Rs.25000 University of Mumbai Minor Research Grant Project Research Grant Project	Ms.Jyoti Dawkar	<b>Electronics &amp; Telecommunication Engineering</b>	<a href="#">52</a>
16	<b>Air pollution monitoring system using WSN</b> 2019-2020 Rs.35000 University of Mumbai Minor Research Grant Project Research Grant Project	Dr. (Ms.) Saylee Gharge	<b>Electronics &amp; Telecommunication Engineering</b>	<a href="#">53</a>
17	<b>Sahara: A stanchion for the blind</b> 2019-2020 Rs.30000 University of Mumbai Minor Research Grant Project Research Grant Project	Dr. Ms. Sharmila Sengupta	<b>Computer Engineering</b>	<a href="#">54</a>
18	<b>Coreveillance- Making our world a "SAFER" Place</b> 2019-2020 Rs.15000 University of Mumbai Minor Research Grant Project Research Grant Project	Ms. Lifna C S	<b>Computer Engineering</b>	<a href="#">55</a>
19	<b>"Food to people: A Block Chain Solution</b> 2019-2020 Rs.25000 University of Mumbai Minor Research Grant Project Research Grant Project	Ms. Abha Tewari	<b>Computer Engineering</b>	<a href="#">56</a>
20	<b>FireMan Helper</b> 2019-2020 Rs.15000 University of Mumbai Minor Research Grant Project Research Grant Project	Ms. Kajal Jewani	<b>Computer Engineering</b>	<a href="#">57</a>
21	<b>Trail-Tracker: Antipoaching Intelligence using AI and IoT</b> 2019-2020 Rs.10000 University of Mumbai Minor Research Grant Project	Ms.Vidya Zope	<b>Computer Engineering</b>	<a href="#">58</a>
22	<b>Preparation and characterisation of complexes of cetyltrimethylammonium bromide and cetylpyridinium chloride with butyl benzene sulphonates without inherent salts.</b> 2019-2020 Rs.40000	Dr. (Ms.) Maya Bhat	<b>Computer Engineering</b>	<a href="#">59</a>



# Vivekanand Education Society's Institute of Technology

(Affiliated to University of Mumbai, Approved by AICTE & Recognized by Govt. of Maharashtra)

	University of Mumbai Minor Research Grant Project			
23	<b>Programmable Computer Controlled Active Analog Filter</b> 2019-2020 Rs.25000 University of Mumbai Minor Research Grant Project	Ms.Namrata Bonde	<b>Instrumentation Engineering</b>	<a href="#">60</a>
24	<b>Maximum Power Point Tracking of Photovoltaic Cell</b> 2019-2020 Rs.25000 University of Mumbai Minor Research Grant Project	Ms.Deepti Khimani	<b>Instrumentation Engineering</b>	<a href="#">61</a>
25	<b>Water Monitoring System using IOT</b> 2019-2020 Rs.20000 University of Mumbai Minor Research Grant Project	Ms.Anushree Prabhu	<b>Electronics Engineering</b>	<a href="#">62</a>
26	<b>Capacity Planning for Public Toilets for Urban Slums</b> 2019-2020 Rs.15000 University of Mumbai Minor Research Grant Project	Ms. Jayashree Hajgude	<b>Information Technology</b>	<a href="#">63</a>
27	<b>"Conversion of Handwritten document into Text"</b> 2019-2020 Rs.15000 University of Mumbai Minor Research Grant Project	Dr.Ramesh Solanki / Dr.(Ms) Dhannama Jagli	<b>Master of Computer Application</b>	<a href="#">64</a>
28	<b>Fraud Prevention on Crowdfunding Platform</b> 2019-2020 Rs.30000 University of Mumbai Minor Research Grant Project	Ms. Asha Bharambe	<b>Information Technology</b>	<a href="#">65</a>
29	<b>Assistive Smart Stick for Independent and Safe Travel</b> 2019-2020 Rs.15000 University of Mumbai Minor Research Grant Project	Ms. Charusheela Nehete	<b>Information Technology</b>	<a href="#">66</a>
30	<b>Parallel Synthesizer with Independent Temperature Control</b> 2019-2020 Rs.35000 University of Mumbai Minor Research Grant Project	Ms.Mugdha Jogalekar	<b>Instrumentation Engineering</b>	<a href="#">68</a>





# Vivekanand Education Society's Institute of Technology

(Affiliated to University of Mumbai, Approved by AICTE & Recognized by Govt. of Maharashtra)

31	<b>Beach cleaning bot</b> 2019-2020 Rs.20000 University of Mumbai Minor Research Grant Project	Ms. Vidya Pujari	Information Technology	<a href="#">73</a>
32	<b>Voice controlled wheelchair</b> 2019-2020 Rs.15000 University of Mumbai Minor Research Grant Project Research Grant Project	Ms. Arti Sawant	Electronics & Telecommunication Engineering	<a href="#">76</a>
33	<b>Semi Autonomous River Cleaning Robot (Search)</b> 2018-2019 Rs.50000 NMMC	Dr. Nadir Charniya	Electronics & Telecommunication Engineering	<a href="#">77</a>
34	<b>Air quality monitoring system for chembur Area</b> 2018-2019 Rs.25000 University of Mumbai Minor Research Grant Project	Mr. Ajinkya Valajoo	Electronics & Telecommunication Engineering	<a href="#">79</a>
35	<b>Infant Incubator intelligent control system</b> 2018-2019 Rs.25000 University of Mumbai Minor Research Grant Project	Ms. Neeta Chavan	Electronics & Telecommunication Engineering	<a href="#">86</a>
36	<b>Smart vehicle for physically challenged people</b> 2018-2019 Rs.20000 University of Mumbai Minor Research Grant Project	Ms. Himali Patel	Electronics & Telecommunication Engineering	<a href="#">87</a>
37	<b>Prototype Design and controller implementation for a battery- ultra capacitor hybrid electric vehicle</b> 2018-2019 Rs.25000 University of Mumbai Minor Research Grant Project	Mr. Shobit Khandare	Electronics & Telecommunication Engineering	<a href="#">88</a>
38	<b>Contagious disease propagation study and containment strategies using Machine Learning : Indian Scenario (Compute Grant)</b> 2018-2019 Rs.700000 Microsoft AI for Earth	Dr. (Ms.) Nupur Giri / Mr. Richard Joseph	Computer Engineering	<a href="#">89</a>
39	<b>Farm Guide (Compute Grant)</b> 2018-2019 Rs.700000 Microsoft AI for Earth	Dr. (Ms.) Gresha Bhatia	Computer Engineering	<a href="#">90</a>



# Vivekanand Education Society's Institute of Technology

(Affiliated to University of Mumbai, Approved by AICTE & Recognized by Govt. of Maharashtra)

40	<b>Rehabilitation and Protection of Coastal Areas (Compute Grant)</b> 2018-2019 Rs.1043000 Microsoft AI for Earth	Mr. Richard Joseph	Computer Engineering	<a href="#">92</a>
41	<b>Water Supply Management and Catchment Control in Drought Prone Regions of Rural India (Compute Grant)</b> 2018-2019 Rs.1043000 Microsoft AI for Earth	Ms. Kajal Jewani	Computer Engineering	<a href="#">94</a>
42	<b>Intelligent Classroom : Students' behaviour and Emotions Analysis using Face Recognition (Compute Grant)</b> 2018-2019 Rs.350000 Microsoft AI for Earth	Ms. Sunita Sahu	Computer Engineering	<a href="#">96</a>
43	<b>Autonomous Luggage carrying Robot using Image Processing</b> 2018-2019 Rs.25000 University of Mumbai Minor Research Grant Project	Ms. Indu Dokare	Computer Engineering	<a href="#">97</a>
44	<b>Transparent and trackable donations using blockchain</b> 2018-2019 Rs.40000 University of Mumbai Minor Research Grant Project	Ms. Rupali Hande	Computer Engineering	<a href="#">98</a>
45	<b>Garuda: The Intelligent Ornithopter</b> 2018-2019 Rs.30000 University of Mumbai Minor Research Grant Project	Ms. Sunita Suralkar	Computer Engineering	<a href="#">110</a>
46	<b>Smart Locker</b> 2018-2019 Rs.30000 University of Mumbai Minor Research Grant Project	Ms. Anjali Yeole	Computer Engineering	<a href="#">111</a>
47	<b>Design and Control of Computer controlled High Resolution Research grade validation system</b> 2018-2019 Rs.20000 University of Mumbai Minor Research Grant Project	Ms. Nilima Warke	Instrumentation Engineering	<a href="#">112</a>
48	<b>Time to digital converter for Nuclear Timing spectroscopy application</b> 2018-2019 Rs.20000 University of Mumbai Minor Research Grant Project	Ms. Kanchan Chavan	Instrumentation Engineering	<a href="#">114</a>



# Vivekanand Education Society's Institute of Technology

(Affiliated to University of Mumbai, Approved by AICTE & Recognized by Govt. of Maharashtra)

49	<b>Recommender System to Identify Influential Individuals on Social Media</b> 2018-2019 Rs.15000 University of Mumbai Minor Research Grant Project	Dr. (Ms.) Shalu Chopra Ms.Pooja Shetty	<b>Information Technology</b>	<a href="#">117</a>
50	<b>Heart Disease prediction using AI (Deep Learning).</b> 2018-2019 Rs.35000 University of Mumbai Minor Research Grant Project	Dr. (Ms.) Shanta Sondur Ms.Charushela Nehete	<b>Information Technology</b>	<a href="#">119</a>
51	<b>Optimized rescue system for accidents and emergencies</b> 2018-2019 Rs.40000 University of Mumbai Minor Research Grant Project	Ms.Sukanya Roychowdhury Ms.Smita Jangale	<b>Information Technology</b>	<a href="#">121</a>
52	<b>Digital India - Smart Subsidy System.</b> 2018-2019 Rs.100000 MHRD	Mr.Amit Singh	<b>Information Technology</b>	<a href="#">122</a>
53	<b>IoT based Waste Management System: A Step towards Smart City"</b> 2018-2019 Rs.30000 University of Mumbai Minor Research Grant Project	Ms. Rohini Temkar, Ms. Sangeeta Oswal	<b>Master of Computer Application</b>	<a href="#">123</a>
54	<b>Search Engine Ranking Prediction &amp; Improvement. Using Neural Networks</b> 2018-2019 Rs.70000 Research Grant by CRG RNTU	Ms Meenakshi Garg	<b>Master of Computer Application</b>	<a href="#">125</a>
55	<b>Mind controlled Assistive Quadrotor Drone.</b> 2017-2018 Rs.25000 University of Mumbai Minor Research Grant Project	Ms. Ashwini Sawant	<b>Electronics &amp; Telecommunication Engineering</b>	<a href="#">126</a>
56	<b>Reinforcement learning on a robot.</b> 2017-2018 Rs.26500 University of Mumbai Minor Research Grant Project	Ms. Nusrat Ansari	<b>Electronics &amp; Telecommunication Engineering</b>	<a href="#">127</a>
57	<b>Vehicle collision avoidance at junctions, blind urns and hairpin bends.</b> 2017-2018 Rs.24000 University of Mumbai Minor Research Grant Project	Ms. Anuradha Jadia	<b>Electronics &amp; Telecommunication Engineering</b>	<a href="#">128</a>



# Vivekanand Education Society's Institute of Technology

(Affiliated to University of Mumbai, Approved by AICTE & Recognized by Govt. of Maharashtra)

58	<b>Electricity Consumption and Home Automation</b> 2017-2018 Rs.40000 University of Mumbai Minor Research Grant Project	Dr. (Ms.) Gresha Bhatia	<b>Computer Engineering</b>	<a href="#">129</a>
59	<b>Speed Regulating mechanism for Road Safety</b> 2017-2018 Rs.40000 University of Mumbai Minor Research Grant Project	Mr. Richard Joseph	<b>Computer Engineering</b>	<a href="#">130</a>
60	<b>App for Aromatic and Medicinal crop growers</b> 2017-2018 Rs.10000 MHRD	Ms.Abha Tewari	<b>Computer Engineering</b>	<a href="#">131</a>
61	<b>Electronic talking gloves for speech disabled people</b> 2017-2018 Rs.20000 University of Mumbai Minor Research Grant Project	Ms.Amudha Senthilkumar	<b>Instrumentation Engineering</b>	<a href="#">132</a>
62	<b>Automatic detection and notification of potholes and humps on roads to save accidents.</b> 2016-2017 Rs.21000 University of Mumbai Minor Research Grant Project	Ms.Rasika Naik	<b>Electronics &amp; Telecommunication Engineering</b>	<a href="#">133</a>
63	<b>Detection of unusual activity in video using unsupervised detection algorithm</b> 2016-2017 Rs.25000 University of Mumbai Minor Research Grant Project	Dr. (Ms.) Saylee Gharge	<b>Electronics &amp; Telecommunication Engineering</b>	<a href="#">134</a>
64	<b>Speaking gloves</b> 2016-2017 Rs.30000 University of Mumbai Minor Research Grant Project	Dr. C. D. Rawat	<b>Electronics &amp; Telecommunication Engineering</b>	<a href="#">135</a>
65	<b>Portable heart attack detection in early stage.</b> 2016-2017 Rs.40000 University of Mumbai Minor Research Grant Project	Ms. Jyoti Bagate	<b>Electronics &amp; Telecommunication Engineering</b>	<a href="#">136</a>
66	<b>Automatic weed detector and herbicide sprayer agricultural robot.</b> 2016-2017 Rs.22000	Ms. Manisha Joshi	<b>Electronics &amp; Telecommunication Engineering</b>	<a href="#">137</a>



# Vivekanand Education Society's Institute of Technology

(Affiliated to University of Mumbai, Approved by AICTE & Recognized by Govt. of Maharashtra)

	University of Mumbai Minor Research Grant Project			
67	<b>Video streaming with multipath TCP and enhanced security.</b> 2016-2017 Rs.25000 University of Mumbai Minor Research Grant Project	Dr. (Ms.) Ranjan Bala Jain	<b>Electronics &amp; Telecommunication Engineering</b>	<a href="#">138</a>
68	<b>Home Automation using Panoramic Image</b> 2016-2017 Rs.20000 University of Mumbai Minor Research Grant Project	Dr. (Ms.) Nupur Giri	<b>Computer Engineering</b>	<a href="#">157</a>
69	<b>Location based alert system using Twitter analytics</b> 2016-2017 Rs.23000 University of Mumbai Minor Research Grant Project	Ms. Lifna C S (Computer Engineering/Information Technology)	<b>Computer Engineering</b>	<a href="#">158</a>
70	<b>Determination of Ultracapacitor Parameters</b> 2016-2017 Rs.25000 University of Mumbai Minor Research Grant Project	Ms. Jayassre Ramakrishnan	<b>Instrumentation Engineering</b>	<a href="#">159</a>
71	<b>Martition Landform Segmentation using Structural Simillarity</b> 2016-2017 Rs.308000 Indian Space Research Organisation(ISRO)	Mr. Abhijeet Shete (PI), Dr. Parmeshwar Birajadar (CO PI), Mr. Yogesh Pandit (CO PI)	<b>Electronics Engineering</b>	<a href="#">160</a>
72	<b>Predictive analysis of carbon footprint in metropolitan cities of India.</b> 2019-2020 Rs.780000 AI for Earth Microsoft Azure Compute Grant	Ms.Priya R L	<b>Computer Engineering</b>	<a href="#">165</a>
73	<b>Predicting floods in coastal regions as a direct consequence of deforestation</b> 2019-2020 Rs.780000 AI for Earth Microsoft Azure Compute Grant	Ms.Abha Tewari	<b>Computer Engineering</b>	<a href="#">166</a>





# Vivekanand Education Society's Institute of Technology

(Affiliated to University of Mumbai, Approved by AICTE & Recognized by Govt. of Maharashtra)



महाराष्ट्र MAHARASHTRA

© 2020 ©

BA 301126



### MEMORANDUM OF UNDERSTANDING

This Memorandum of Understanding ("MOU") is made at Mumbai on this \_\_\_ day of December 2020;

BETWEEN

Star Union Dai-ichi Life Insurance Co. Ltd., a Company incorporated under the Companies Act, 1956 having its registered office at 11<sup>th</sup> Floor, Vishwaroop IT Park, Plot No. 34, 35 & 38, Sector - 30A, Opp. Vashi Railway Station, Vashi, Navi Mumbai - 400703 India, (hereinafter referred to as "SUD Life" which expression shall unless repugnant to the meaning or context thereof also mean and include its successors and assigns) of ONE PART;

AND



WHEREAS VESIT-IT is an Educational institution and has undertaken a project of Municipal Corporation of Greater Mumbai for the Development of IT enabled solution for operation, maintenance & monitoring of community toilet & public toilet in M-East ward of the City of Mumbai in consultation with CT/PT operators and MCGM ("Swechchha Project").

AND WHEREAS the Swechchha Project has been awarded to VESIT-IT vide a duly notarised MOU signed on 2<sup>nd</sup> November 2020 & 25<sup>th</sup> September 2020 between Municipal corporation of greater Mumbai and Vivekanand Education Society's Institute of Technology ("VESIT-IT-MCGM MOU"), which is attached as Annexure 1 of this MoU.

AND WHEREAS Based on representations made by VESIT-IT, the SUD Life intends to provide financial assistance for Swechchha Project as per the project plan submitted by VESIT-IT which is attached as Annexure 2 on the agreed terms and conditions mentioned in this MOU and this financial support shall be under CSR initiative of the SUD Life.

NOW THIS MOU WITNESSETH AND IT IS HEREBY AGREED BY & BETWEEN THE PARTIES HERETO AS FOLLOWS:

#### 1. Sponsorship

SUD Life shall in pursuance of its Corporate Social Responsibility and objectives initially intend to provide financial assistance for the Swechchha Project at M-east Ward of Municipal Corporation of Greater Mumbai which shall be completed in next two (2) years i.e. January 2021 to December 2022 as mentioned in the Table in Annexure 2 and the scope as more specifically mentioned in the VESIT-IT-MCGM MOU. The completion period of the Swechchha Project for M-east Ward of Municipal Corporation of Greater Mumbai may be extended for a maximum period of 6 months (except in case of delay arising due to happening of any Force Majeure Event). Any further extension shall be agreed in writing by both the parties. For the next phase of the Swechchha Project to cover Mumbai Jurisdiction or pan India, the parties will separately agree on terms and conditions including total project cost. Any changes in the requirement resulting in financial implications shall be pre-approved in writing by SUD Life. SUD Life may at its sole discretion also choose to discontinue disbursement of further financial support, in case of unauthorised deviation from approved plan. SUD Life shall be required only to provide financial support subject to terms and conditions of this MOU and shall not have any liability of whatsoever nature for any deficiency or delay in the Swechchha Project caused by VESIT-IT or any 3<sup>rd</sup> party.

#### 2. Utilisation of Funds

VESIT-IT agrees to utilise the funds of Financial Support only for the Swechchha Project for the activities as specifically mentioned in Annexure 2 of this MOU and shall not utilise it for any other activity. VESIT-IT shall utilise the fund within a period of two (2) years. VESIT-IT may take an additional period of six (6) months for utilising the funds for the Swechchha Project, subject to prior intimation to SUD Life. VESIT-IT agrees that it shall not transfer any part of the Financial Support and/or any assets created/purchased from the funds of Financial Support, to any other person, without the prior written consent of SUD Life.

#### 3. Representation and Warranties of VESIT-IT

VESIT-IT covenants to SUD Life that:

- (i) It has full power, capacity and authority to sign, execute, deliver and comply with the terms and conditions laid down herein and shall take all necessary action (corporate, statutory or otherwise) to execute and authorize the execution, delivery and performance of this MOU.
- (ii) It has all the prior permission or registration approvals under applicable laws in relation to receiving contribution from the SUD Life.

It has approval and permission from MCGM & other necessary authorities to consider and





display the name & logo of SUD Life as Financial Partner for the Project at all places including the applications and other promotional material.

- (iv) The use of Financial Assistance provided by the SUD Life shall be utilised only for the Sponsorship Activity as mentioned in **Annexure 2** of this MOU.
- (v) Any deviation from the approved plan shall be agreed in writing by SUD Life
- (vi) It shall comply with and agree to comply with all applicable laws, regulatory requirements whilst undertaking the said plan to execution and SUD Life is not responsible for any statutory compliance and its role is purely restricted to financial assistance.
- (vii) It shall maintain confidentiality of the terms of this MOU.
- (viii) It is not stopped by any law or any other agreement with any party to execute this MOU with SUD Life.
- (ix) It has obtained permission and consent from MCGM for entering into this MOU and agreeing for its obligation to perform.
- (x) Represented that during the term of this MOU or for such extended period as mentioned in this MOU shall not enter into a similar MOU with any other party inducting them as a partner in the Swechchha Project.
- (xi) nothing in this MOU shall create or be deemed to create any relationship of partnership or control over the management of VESIT-IT.

#### 4. VESIT-IT Obligation

- a. It is hereby clarified that the role of SUD Life will be limited only in providing Financial Support in accordance with the terms and conditions of this MOU. The Parties hereby agree that VESIT-IT shall be responsible for the actual implementation of the Swechchha Project. It shall be the obligation of the VESIT-IT to utilize the funds of Financial Support received from SUD Life for the implementation of said Swechchha Project only.
- b. VESIT-IT shall liaison with the Municipal Corporation of Greater Mumbai & other entities as required for the implementation of the Swechchha Project including arranging for requisite place/ infrastructure as may be required for the implementation of the Swechchha Project.
- c. It is agreed between the Parties that VESIT-IT shall submit the reports to SUD Life on a monthly basis or such periodical intervals or as and when required by SUD Life. The format of the Swechchha Project report/ Funds Utilisation report shall be mutually agreed between the parties.
- d. VESIT-IT hereby undertake, to fully demonstrate by way of invoices, receipts or any other documents, to SUD Life of expenses already incurred/committed by it.
- e. Without prejudice to its rights under this MOU, the Parties agree that SUD Life shall be entitled to seek any clarifications whatsoever from VESIT-IT with respect to utilization of the Funds for the Swechchha Project. Any such clarification sought by SUD Life shall be answered by VESIT-IT within such time as informed by SUD Life.
- f. VESIT-IT shall designate a competent person to coordinate with SUD Life and shall provide the contact details of such designated person.
- g. VESIT-IT agrees to allow SUD Life's employees or authorised representatives to visit the place where Swechchha Project work is being carried out or implemented and meet people who are involved in the Swechchha Project on prior written intimation.
- h. VESIT-IT shall ensure obtaining all permissions/approvals as are required for the implementation of this Swechchha Project and shall share such approvals with SUD Life as and when demanded for.
- i. VESIT-IT undertakes to be responsible for any issue / dispute in respect of any matter whatsoever with regard to the Swechchha Project.
- j. VESIT-IT shall periodically submit a request letter for release of Financial Support as per the progress of the Swechchha Project along with relevant supporting documents.

#### 5. Covenant of VESIT-IT

VESIT-IT has represented to SUD Life that the Swechchha Project being subject of this MOU is an initial Project for a period of two (2) years for M-east Ward of Municipal Corporation of Greater Mumbai. Based on the successful execution of this Swechchha Project, other Projects would be awarded to VESIT-IT in the





said Municipal Corporation for other wards; and/or other districts within the state of Maharashtra; and/or other states in India.

VESIT-IT hereby Covenants with SUD Life that:

- a. SUD Life shall be sole & exclusive financial partner for this Swechchha Project
- b. Notwithstanding anything contained in this MOU; VESIT-IT shall ensure to recognize SUD Life by displaying the name and logo (as shared by SUD Life) as its exclusive financial partner for the Swechchha Project in all the online and offline promotion including but not limited to print media, broadcasting, mass media platforms, etc., during the period as under:
  - If MCGM does not award VESIT-IT for future maintenance of the Swechchha project, name and logo of SUD Life shall be used for the terms of this MOU and wherever, the name and logo of VESIT-IT shall be used by MCGM as a developer, the name and logo of SUD Life shall be used as development financed by SUD Life
  - If MCGM awards VESIT-IT for maintenance of the Swechchha project and SUD Life does not finance the maintenance of the project, name and logo of SUD Life shall be used for 5 years from the date of signing of MOU as development financed by SUD Life
  - If MCGM awards VESIT-IT for maintenance of the Swechchha project and SUD Life also agrees to finance the maintenance of the project, the name and logo of SUD Life shall be used as per fresh agreement with VESIT-IT.
- c. In case, other similar Projects are awarded to VESIT-IT, for other Wards or locations for the whole of Maharashtra or PAN India, then SUD Life shall be given first right of refusal. Only, if SUD Life refuses to grant its acceptance to finance such other Projects, then only VESIT-IT may approach others for inducting them as a partner.

#### 6. Financial Assistance and Payment Terms

- a. The Total Sponsorship Support under this MOU for the Swechchha Project is restricted to a maximum of INR 24,00,000/- (Rupees Twenty-Four Lakhs Only).
- b. Any excess amount, if any incurred by VESIT-IT for the Swechchha Project shall be mutually discussed between the parties. SUD Life to incur the additional cost, only to the extent as explicitly agreed in writing by SUD Life.
- c. The aforesaid amount shall be remitted in a staggered manner over a period of 2 years, subject to completion of each milestone in the Swechchha Project.
- d. After completion of each Swechchha Project milestone, VESIT-IT shall provide confirmation to SUD Life along with supporting documents and the same shall be certified by the Audit Team of SUD Life.
- e. Only on achieving the milestone for which the financial support was released, the funding for next activity would be released. In case of unutilised amount for any activity, the further funding, if SUD Life agrees to release, then the same shall be subject to deduction of the earlier unutilised amount.
- f. The schedule of remitting financial support shall be as per Annexure 3 of this MOU.

#### 7. Branding

- a. VESIT-IT shall ensure that branding of SUD Life and/or Star Union Dai-ichi Life Insurance Co. Ltd. ("SUD Life") shall be visible on the website/ applications or any promotional and/or other materials developed for the Swechchha Project in all online and offline platforms including but not limited to print media, broadcasting, mass media platforms, etc.
- b. The logo of SUD Life shall be as annexed with Annexure 4 of this MOU unless changed and informed in writing by SUD Life to VESIT-IT. The logo may also be used in vernacular language and shall be provided by SUD Life.
- c. Notwithstanding the MOU is in force or expired or terminated for whatsoever reason, VESIT-IT agrees to ensure that the Branding as a Financial Partner shall be used for the Swechchha Project as specifically mentioned in clause 5(c) of this MOU.
- d. VESIT-IT shall use the branding of SUD Life and SUD Life only in the format & style as provided by SUD Life and shall not carry any changes of whatsoever nature without prior written consent of authorised signatory of SUD Life.





- e. VESIT-IT shall not use the name & logo of any other company in the Swachhha Project without prior express written consent of SUD Life. Any breach of this term shall be considered as material breach of the terms and conditions of this MOU and such default shall be liable for cost and damages.
- f. VESIT-IT acknowledges that the trademark and trade name and all trademarks and trade names of SUD Life or SUD Life are the exclusive property of SUD Life or its affiliated companies; and VESIT-IT is not entitled, either by implication or otherwise, to any title in or use of the Trademarks, except in accordance with the express written permission of the authorised signatory of SUD Life, such permission to be given or withheld at the sole discretion of SUD Life.
- g. In case of any changes in the branding of SUD Life; SUD Life shall inform accordingly to VESIT-IT and VESIT-IT shall be under obligation to carry such changes of all the existing online and offline platforms or if under process of being developed, without any cost obligation on SUD Life.
- h. Notwithstanding anything contained in this MOU, during the subsistence of this MOU or on termination, SUD Life at its sole discretion may instruct in writing to VESIT-IT to temporarily or permanently discontinue usage of the branding of SUD Life and VESIT-IT shall be under obligation to immediately discontinue such usage, without any cost obligation on SUD Life.

#### 8. INDEMNITY

- a. VESIT-IT further agrees to hold harmless and indemnify SUD Life and SUD Life and its employees from and against any and all losses, claims, damages, proceedings, judgments, liabilities, fees, expenses and disbursements relating to or arising out of (i) misuse of the Financial Support received from SUD Life or (ii) any breach of the covenants/ provisions contained in the MOU or (iii) infringement of any 3<sup>rd</sup> party IPR; or (iv) breach of applicable law; or (v) any act or omission of VESIT or its employees, agents etc., while implementation of the Swachhha Project.
- b. Notwithstanding anything contrary contained in this MOU, neither party shall not be liable for any special, indirect, consequential, or incidental damages (including but not limited to damages for loss of business profits, business interruption, loss of business information, and the like) arising out of this MOU, any documents referenced in this MOU, or any addenda or amendment hereto.  
This clause shall survive the expiry or the earlier termination of this MOU.

#### 9. Term & Termination

- a. This MOU shall come into effect from the date of its execution and shall remain valid for a period of two (2) years or the date of completion of the Swachhha Project, whichever is later.
- b. Notwithstanding anything contained hereinabove, SUD Life may forthwith terminate this MOU, without notice and with immediate effect for any of the following reasons
  - i. In the event of any regulatory directive or deviation from the terms of this MOU, SUD Life can forthwith terminate this MOU.
  - ii. Gross negligence or fraud by VESIT-IT or any of its representative or employees, while implementation or operation of the Swachhha Project
  - iii. Dissolution of Financial Support by VESIT-IT for any other purpose than the one specified in the MOU hereof.
  - iv. Breach of any terms and conditions of this MOU or VESIT-IT-MCGM MOU
- c. In case of termination, prior to full utilization of the Financial Support and/or completion of the Swachhha Project, any unutilized Financial Support shall be refunded by VESIT-IT to SUD Life without any demur or protest. VESIT-IT hereby undertake, to fully demonstrate by way of invoices, receipts or any other documents, to SUD Life of expenses already incurred/committed by it on the Swachhha Project till the time of termination.
- d. Notwithstanding anything contained in this MOU, it is agreed that the obligation of VESIT-IT as mentioned in clause 7 (Branding) shall continue even post expiry/ termination of the MOU.

#### 10. CONFIDENTIALITY

VESIT-IT hereby acknowledges and agrees that any and all confidential information howsoever related to SUD Life or SUD Life, applied to VESIT-IT by or on behalf of SUD Life and/or which may be made available to VESIT-IT by any of its advisors, officers or employees or otherwise learned by VESIT-IT



course of the provision of Services under this MOU will be treated by VESIT-IT as being information of a confidential nature ("Confidential Information").

VESIT-IT shall:

- a. not use any of the Confidential Information under this MOU otherwise than for the purpose of performing its obligations under this MOU;
- b. At all times, during and after the Term, maintain the confidentiality of the Confidential Information and any copies, photographs, drawings or recordings of any type whatsoever of any of the Confidential Information using the same standards of protection as it applies to its own confidential information;
- c. Only make available the Confidential Information to such of its employees, contractors, agents and professional advisors as required to perform the obligations under this MOU and further have been informed by VESIT-IT of the confidential nature of the Confidential Information and of their obligations in respect thereof;
- d. Forthwith on request of SUD Life and in accordance with such request or upon termination of this MOU either:
  - (i) Return to SUD Life all of the Confidential Information together with all copies, notes or records derived there from and without retaining any copies of the same; and
  - (ii) Destroy all of the Confidential Information which is together with all copies, notes or records derived there from including anything stored in electronic medium and provide a certificate to the same effect.

This Clause does not pertain to the information which is in public domain otherwise than by the reason of any breach of this MOU.

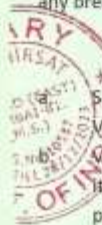

#### 11. Audit & Inspection

SUD Life or its auditors and regulators, will have the right from time to time to conduct audits of VESIT-IT for accounts pertaining to Project Swechchha.

VESIT-IT will provide SUD Life and all other persons conducting an audit, with reasonable access to its facilities, software, data, records, and personnel for the purpose of performing such audits pertaining to Project Swechchha and shall provide such persons with any assistance that may be reasonably required in connection with such audit. VESIT-IT ensures to cooperate with the auditors performing audits pertaining to Project Swechchha by or on behalf of SUD Life.

- c. The Parties shall develop and follow procedures for the sharing of audit and regulatory findings related to the provision or receipt of the Services. VESIT-IT agrees to respond in writing to any observations made by any audit and shall at its own cost and expense diligently rectify, as appropriate and as agreed with SUD Life, all shortcomings identified in the course of an audit which fall within the defined scope of the Services within the time periods agreed to.
- d. The audit and regulatory personnel engaged by SUD Life shall be governed by the confidentiality clause under this MOU

#### 12. Anti-Bribery

VESIT-IT confirms that it shall conduct its business in compliance with applicable anti-bribery and corruption laws. It further confirms that it shall not directly or indirectly offer, promise, pay, accept, receive, or solicit a bribe of any kind, to or from any person or entity in order to obtain favourable treatment in the Swechchha Project or any such advantage or for any other purpose. It further represents and confirms that it has not been the subject of any investigation, inquiry or enforcement proceedings by any governmental, administrative or regulatory body regarding any offence or alleged offence under applicable anti-bribery and corruption laws.

#### 13. Dispute Resolution

This MOU shall be governed by and construed/enforced in accordance with the laws of India. The courts of Mumbai shall have exclusive jurisdiction to try and settle any dispute or controversy arising





MOU. Any and all disputes or differences between the Parties arising out of or in connection with this MOU or its performance or the rights, duties or obligations of the Parties hereunder shall (the "Disputes"), so far as it is possible, be settled amicably through consultation between the senior management of the Parties and if not successfully resolved, then the same shall be resolved through arbitration by a sole arbitrator to be mutually agreed by the parties. The arbitration shall be in accordance with the Arbitration & Conciliation Act, 1996 and place of arbitration shall be Mumbai.

#### 14. Force Majeure

If at any time during the term of this MOU, the performance in whole or in part by VESIT-IT of any obligation under this MOU is prevented or delayed by reasons of any war, acts of the public enemy, major civil commotion, major fires, major floods, serious explosions, epidemics, pandemic, major strikes and lockouts or act of God (hereinafter referred to as "Force Majeure Event"), notice of happening of any Force Majeure Event shall be given by VESIT-IT to SUD Life within two (2) days from the date of occurrence thereof and shall resume Swachhha Project as soon as possible after such a Force Majeure Event comes to an end or ceases to exist. Both the parties agree that the current pandemic of COVID-19 shall not be considered as Force Majeure, unless specific stringent restrictions are imposed by the government, completely affecting the ability to perform by either party. In the event the Swachhha Project does not commence, by reason of such Force Majeure Event for a period exceeding fifteen (15) days, SUD Life, at its option can terminate the MOU without incurring any liability unless otherwise mutually agreed between the Parties in writing and shall be entitled to seek refund and VESIT-IT shall be under obligation to return the financial support already remitted by SUD Life, but remain unutilized.

#### 15. Notice

Any notice, direction or other documentation required or remitted to be given hereunder shall be in writing and may only be given by personal delivery, courier, (with confirmation received) at the addresses hereinafter set forth:

##### For SUD Life SUD Life

Kind Attn: Rajesh Mourya  
Address: 11<sup>th</sup> Floor, Vishwaroop IT Park, Near Vashi Railway Station, Sector 30A, Vashi, Navi Mumbai – 400 703

##### For Vivekanand Education Society's Institute of Technology

Kind Attn: Dr. (Mrs.) M. Vijayalakshmi – Department of Information Technology  
email: M Vijayalakshmi <m.vijayalakshmi@ves.ac.in>  
Kind Attn: Dr. (Mrs.) Shanta Sondur – Department of Information Technology  
email: Shanta Sondur <shanta\_sondur@ves.ac.in>  
Address: Hashu Advani Memorial Complex, Collector's colony, Chembur, Mumbai – 400074  
Tel: (022) 6153 2500

#### 16. Miscellaneous

- If any section or paragraph, or part thereof, of this MOU or any document appended hereto or made a part hereof is rendered invalid, ruled illegal by any court of competent jurisdiction, or unenforceable under present or future laws effective during the term of this MOU, then it is the intention of the Parties that the remainder of the MOU, or any document appended hereto or made a part hereof, shall not be affected thereby.
- VESIT-IT shall not assign this MOU in whole or in part to any other party, without the prior written consent of SUD Life.
- The relationship between SUD Life and VESIT-IT is that of principal to principal basis.
- This MOU together with the Annexure and any supplements executed between the Parties hereto, constitutes the entire understanding between the Parties hereto with respect to the matters dealt with herein and supersedes any previous Agreement/ MOU, whether in oral or in writing, between







# Vivekanand Education Society's Institute of Technology

(Affiliated to University of Mumbai, Approved by AICTE & Recognized by Govt. of Maharashtra)

- the Parties hereto in relation to such matters.
- e. Addendums: No modifications, amendment or waiver of terms and conditions of this MOU shall be binding unless made specifically in writing and upon the mutual consent of the Parties.

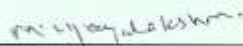
IN WITNESS WHEREOF the parties hereto have set their hands and seals on the day and year first above written.

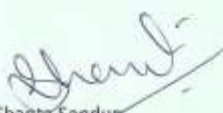
For Star Union Dai-ichi Life Insurance Co. Ltd. 	For Vivekanand Education Society's Institute of Technology 
Name: Rakesh Kumar	Name: Dr. (Mrs.) M. Vijayalakshmi
Title: Company Secretary	Title: Vice-Principal, VESIT
Date: 18 <sup>th</sup> December 2020	Date: 18 <sup>th</sup> December 2020
Place: Chembur, Mumbai	Place: Chembur, Mumbai
WITNESS  Ms. Rajesh Mourya	WITNESS  Dr. (Mrs.) Shanta Sondur



BEFORE ME  
  
18/12/2020  
P. N. SHIRSAT  
M.Com., LL.B., F.I.C.S.  
ADVOCATE & NOTARY  
MULLIND (EAST), MUMBAI-81,  
MAHARASHTRA STATE



# Vivekanand Education Society's Institute of Technology

(Affiliated to University of Mumbai, Approved by AICTE & Recognized by Govt. of Maharashtra)



### MEMORANDUM OF UNDERSTANDING

BETWEEN

Municipal Corporation of Greater Mumbai

AND

Vivekanand Education Society's Institute of Technology's Department  
of Information Technology (VESIT-IT).



Vice-Principal  
Vivekanand Education Society's  
Institute of Technology  
Hashu Advani Memorial Complex,  
Collector Colony, Chembur,  
Mumbai-400 074 INDIA





# Vivekanand Education Society's Institute of Technology

(Affiliated to University of Mumbai, Approved by AICTE & Recognized by Govt. of Maharashtra)

(-193

## MEMORANDUM OF UNDERSTANDING

This Memorandum Of Understanding (MoU) is made on \_\_\_\_\_

### BY AND BETWEEN

Jt. Municipal Commissioner (Solid Waste Management), Municipal Corporation of Greater Mumbai, having its office at 3<sup>rd</sup> Floor, Annex Building, Mahapalika Marg, C.S.T. Mumbai - 400001, hereinafter referred to as "MCGM" (which expression shall be deemed to mean and include its successors and permitted assigns) through its Municipal Commissioner, Mr. Iqbal Singh Chahal, IAS.

### AND

Vivekanand Education Society's Institute of Technology, affiliated to University of Mumbai, approved by AICTE and recognized by Government of Maharashtra, located at Hashu Advani Memorial Complex, Collector's Colony, Chembur, Mumbai-400074, an institute established in 1984 by Vivekanand Education Society, hereinafter referred to as "VESIT -IT", (which expression shall be deemed to mean and include its successors and permitted assigns) through its Vice-Principal Dr. (Mrs.) M. Vijayalakshmi.

### WHEREAS

- Municipal Corporation of Greater Mumbai (MCGM), is responsible for city planning, resource allocation and management, delivery of infrastructure & services and overall administration and citizen welfare of Greater Mumbai.
- VESIT-IT is the department of Information Technology at Vivekanand Education Society's Institute of Technology (VESIT).
- VESIT-IT and MCGM seek to collaborate for developing an IT enabled solution for operation, maintenance and monitoring of Community Toilet (CT) and Public Toilet (PT) blocks in M East ward of the city of Mumbai in consultation with CT/PT operators and MCGM.

The parties hereto in consideration of the mutual covenants set forth herein and subject to the terms and conditions set forth in this Memorandum of Understanding agree as follows:

NOW THIS MEMORANDUM OF UNDERSTANDING WITNESSETH AS UNDER:

I. Scope

Vice-Principal  
Vivekanand Education Society's  
Institute of Technology  
Hashu Advani Memorial Complex,  
Collector Colony, Chembur,  
Mumbai-400 074 INDIA

Scanned with CamScanner

C-20

VESIT-IT shall act as a knowledge partner to MCGM for developing an IT enabled solution for operation, maintenance and monitoring of Community Toilet (CT) and Public Toilet (PT) in the M East ward of the city of Mumbai, in collaboration with Community Based Organizations (CBOs), Non Governmental Organisations (NGOs) and MCGM.

Scope of the engagement would include but is not limited to the following:

#### 1. A Mobile App on Android and IOS:

- a. CBO/NGO members for easing operation and maintenance of CT/PT blocks
- b. Respective users of a community/floating population in registering their complaints and giving feedbacks.
- c. Facilitating contact of respective authorities in case of emergencies.
- d. Assisting MCGM in collecting the data useful in knowing the utility of CT/PT blocks and the usage of the funds in the Slum Sanitation Program.
- e. Facilitating toilet search for a traveller in the city. (Toilet Finder)
- f. notifying current 'cleanliness and usability' status of the toilet block to users and authorities
- g. To facilitate User Profile Management
- h. To provide Toilet usage History
- i. For Record keeping of payments done by user ( for toilet use)
- j. To assess Feedback and Complaint mechanism
- k. To provide Emergency Contact
- l. Notification/ alert System
- m. Bug fixing and maintenance for M East Ward.

#### 2. A website:

- a. For creation and maintenance of Account for different stakeholders like
  - i. MCGM officials
  - ii. CBOs
  - iii. NGOs
  - iv. CBO Federation Representatives
  - v. Other Users (As required)
- b. for ease of data handling/logging
- c. for generating custom reports with analytics for MCGM officials to act as a decision support system for MCGM.
- d. Handholding, Awareness and Training Programme for community people/ PT operators and MCGM staff.
- e. By Creation of user (roles).
- f. By Registration of CBOs belonging to

Vice-Principal  
Vivekanand Education Society's  
Institute of Technology  
Naraina Avenue, S. V. Rd.,  
Chembur, Mumbai - 400 074 INDIA





# Vivekanand Education Society's Institute of Technology

(Affiliated to University of Mumbai, Approved by AICTE & Recognized by Govt. of Maharashtra)

C-203

- g. To facilitate Asset Management for registered CBOs.
- h. To facilitate Simple reports for MCGM officials and CBOs.
- i. To provide Complaint Redressal System.
- j. By Bug fixing and maintenance for M East ward.

## II. Roles and Responsibilities of VESIT-IT:

- a. Seeking funds through Corporate Social Responsibility (CSR) for funding the project and for the sustainment and maintenance of the App in M East ward of MCGM.
- b. Implementation and maintenance of the Mobile app and Website.
- c. Data collection using paper based form with help of CBO members with the support of MCGM staff at M East ward.
- d. CBO and User/Citizen Registration on the website/mobile App monitored by CBO members and MCGM staff at M East ward.
- e. Bug fixing and maintenance for M East ward.
- f. Creating awareness and popularizing the app for sustainability (through Advertisement). Marketing and awareness can be done by propagating websites and mobile apps for revenue generation, for awareness advertise on social media, you tube channel, newspaper and mouth publicity. Advertisement on existing MCGM portal and App based on permissions. For self sustainment of CBOs, product manufacturer, specifically in sanitization area may be contacted, to either sponsor or advertise their product on the app as well as on website.
- g. Handholding, Awareness and Training Programme for community people/ PT operators, CBO officers of all wards, CBO federation and MCGM SWM staff, mock demonstration, prepare stakeholders to handle future apps. Role specific training for CBO officers and CBO federation, MCGM staff pertaining to M East ward of MCGM.
- h. Develop an infrastructure for Data Management for the pilot project.
- i. Enabling two way API integration between the website and various MCGM apps / services as suggested by MCGM.
- j. Monitoring of website and mobile app usage.
- k. To provide Helpdesk and Post Implementation Support during contract period. Online and offline support will be provided to M East ward as and when required.
- l. Facilitator of all IT works within the scope of the project.
- m. A detailed project plan outlining clear timelines for all activities to be submitted to MCGM within 30 days from the date on which the MoU comes into effect.

Vivekanand Education Society's  
Institute of Technology  
Hastur Abirani Memorial Campus  
Collector Colony, Chembur,  
Mumbai - 400 074, India

Scanned with CamScanner

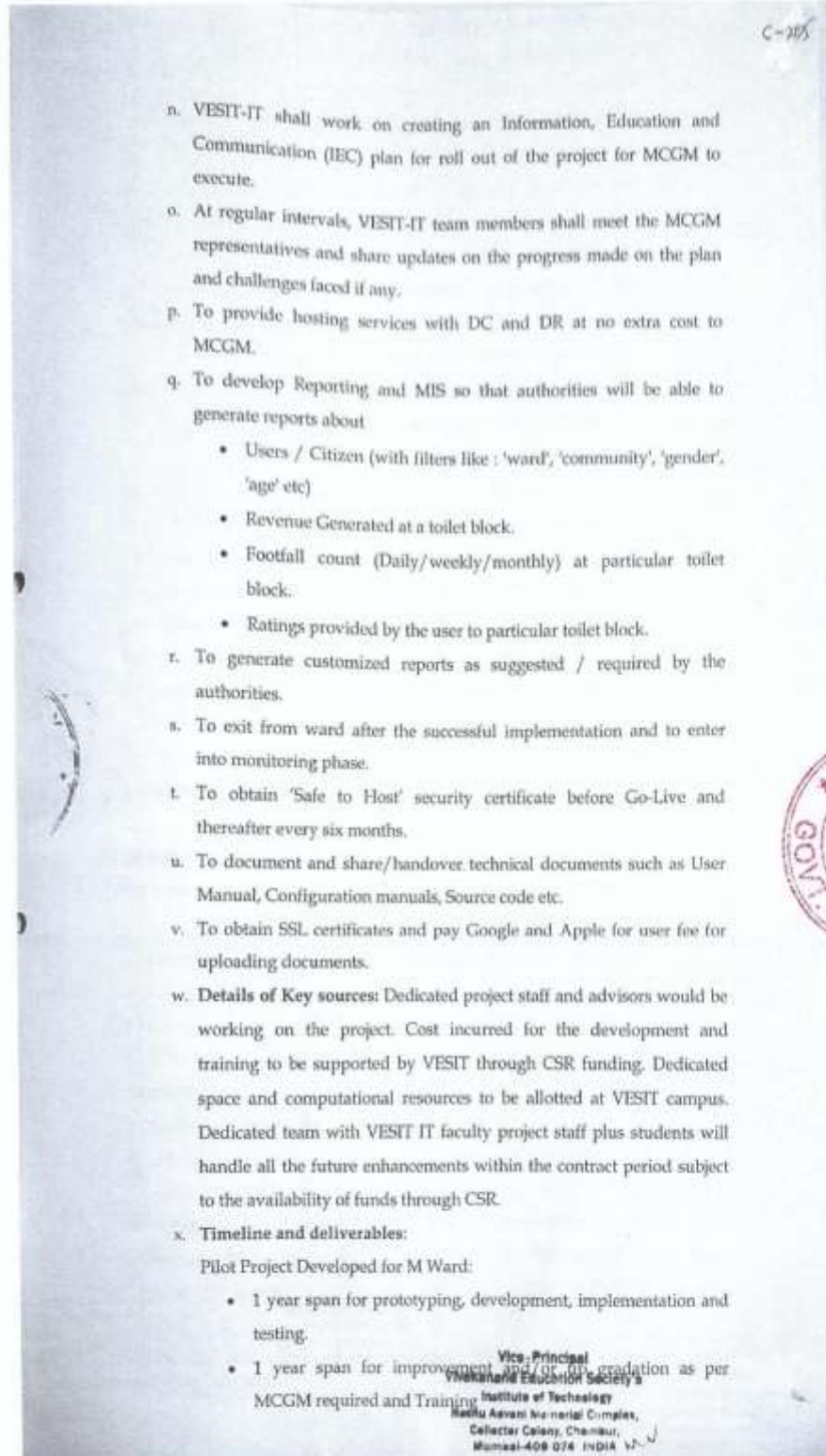



# Vivekanand Education Society's Institute of Technology

(Affiliated to University of Mumbai, Approved by AICTE & Recognized by Govt. of Maharashtra)

Deliverables would include the Mobile App and Website along with technical Documentation.

### III. Roles and Responsibilities of MCGM:

- 1) MCGM shall provide necessary assistance in popularizing and creating awareness of the Mobile App / Website.
- 2) MCGM shall provide Ward Level Map and Details of Public Toilet and Community Toilet Blocks in M East ward.
- 3) MCGM shall provide details of CBOs and CBO Federation.
- 4) MCGM shall provide a hierarchy of officials to be incorporated as a role in the Mobile App/Website, also the official email IDs of these authorities to enable Single Sign-On (SSO) if needed.
- 5) MCGM shall provide mapping of Engineers to Wards and to Civic Issue Categories In M East Ward.
- 6) MCGM shall ensure the MCGM technical team works with VESIT-IT development team to enable the two way API integration if/when needed.
- 7) MCGM shall provide GIS information of CT / PT blocks if already available. If and where this information is not available MCGM may provide necessary assistance to VESIT-IT team in gathering such information.
- 8) MCGM shall encourage the usage of Mobile App and Website by CBOS/PT operators, ward officials and senior officials as required.

### IV. Term

This Memorandum of Understanding shall come into effect immediately on signing of the same by both the parties and shall remain in force until \_\_\_\_\_.

### V. Intellectual property and Data ownership

- 1) VESIT-IT shall be credited as the developer for the entire duration of existence of the platform. For the purpose of the project VESIT may approach CSR funds whose entity will be credited on the platform.
- 2) All data generated by the deployment of the Platform for MCGM will be sole property of MCGM, however VESIT-IT shall seek the prior permission from MCGM to if they wish to use the data for academic research purpose. The status update/progress related reports relevant to the project can be shared with CSR sponsor. Any data available in public domain can be used by CSR firm.
- 3) The Intellectual Property Rights in all Standard Software and Standard Materials shall remain vested with MCGM. However, VESIT-IT shall retain the right to use the same for its internal purposes.

Vice-Principal  
Vivekanand Education Society's  
Institute of Technology  
Hashu Admani Memorial Campus,  
Colaba Colony, Chembur,  
Mumbai-400 074 (Mumbai)

Scanned with CamScanner





# Vivekanand Education Society's Institute of Technology

(Affiliated to University of Mumbai, Approved by AICTE & Recognized by Govt. of Maharashtra)

C-159

NOC from MCGM if they wish to implement this application in other Government agencies/Municipal Corporations in or outside Maharashtra.

4) The Intellectual Property Rights in all Custom Software and Custom Materials shall, vest in MCGM. VESIT-IT shall do and execute or arrange for the doing and executing of each necessary act, document, and thing that MCGM may consider necessary or desirable to perfect the right, title, and interest of MCGM in and to those rights. In respect of such Custom Software and Custom Materials, VESIT-IT shall ensure that the holder of a moral right in such an item does not assert it, and VESIT-IT shall, if requested to do so by MCGM and where permitted by applicable law, ensure that the holder of such a moral right waives it.

5) No license to a party, under any trademark, patent, copyright, design right, mask work protection right, or any other intellectual property right is either granted or implied by the conveying of Confidential Information to such party.

**VI. Dispute resolution and Jurisdiction:**

The provisions of this Memorandum of Understanding shall be governed by, and construed in accordance with Indian law, and any dispute, controversy or claims arising out of or relating to this Memorandum of Understanding shall be settled by arbitration in accordance with the Indian Arbitration and Conciliation Act, 1996. The reference of the dispute shall be to a sole arbitrator if the parties agree upon one, failing that each party shall appoint one arbitrator, and the arbitrators so appointed shall appoint the third presiding arbitrator. Arbitration proceedings shall be held in Mumbai, and the language of the proceedings shall be English. Subject to the provisions for arbitration above, this MoU shall be subject to the jurisdiction of the Courts in Mumbai.

**VII. Notices:**

Any notice or other communication required or permitted to be given hereunder shall be in writing and dispatched by hand delivery or Registered Post Acknowledgement Due (RPAD) or by courier to the address specified below, and shall be deemed sufficiently made or given on the date of delivery if delivered by hand, or on the date of mailing if dispatched by registered post acknowledgement due or by courier. Either party may change its address, by written notice to the other.

The following documents are and shall be deemed to form part of this MoU and shall be read and construed to be part of this MOU as if they were incorporated in this MoU.

a. The letter issued to recognize Department of Information

**Vivekanand Education Society's  
Institute of Technology  
MCGM Regional Complex,  
Collector Colony, Chembur,  
Mumbai-400 074 India**





# Vivekanand Education Society's Institute of Technology

(Affiliated to University of Mumbai, Approved by AICTE & Recognized by Govt. of Maharashtra)

C-211

(IT) of Vivekanand Education Society's Institute of Technology (VESIT-IT), as a knowledge partner in development of the ITeS based solution for operation and maintenance and monitoring of Community Toilet (CT) and Public Toilet (PT) in M East ward in the city of Mumbai, in collaboration with CBOs, NGOs and MCGM vide no. Ch.E/SWM/2810  
dt. 19/8/2020

b. Non Disclosure agreement between MCGM and VESIT-IT.

## VIII. Indemnity:

Vivekanand Education Society's Institute of Technology (VESIT-IT) shall keep the MCGM, their officers and servants harmless and indemnified from and against all losses suit, damages, cost, charges, claims and demands whatsoever including claims under the Workmen's Compensation Act, 1923 which their officers or servants may sustain, incur or become liable to pay for the reason or in consequence of any injury to any person or persons or to any property either belonging to the MCGM or any third party whether resulting directly through any accident or otherwise to life or property while carrying out any work pertaining to the said contract. Such damage, injury or loss to life or property shall be made good and/or as the case may be shall be paid immediately by the Vivekanand Education Society's Institute of Technology (VESIT-IT).

## MCGM

Mr. Arundhanee Sharma, JL-MC(SWM)  
Municipal Corporation of Greater Mumbai  
3rd Floor, Annex Building, Mahapalika Marg,  
CST, Mumbai- 400001  
Tel: +91 22 22620251 / 022 - 22616831  
Email: [dmc.swm@mcm.gov.in](mailto:dmc.swm@mcm.gov.in)

## VESIT-IT:

Dr. (Mrs.) M. Vijayalakshmi  
Dr. (Mrs.) Shanta Sondur  
Department of Information Technology,  
Vivekanand Education Society's Institute Of Technology,  
Hashu Advani Memorial Complex, Collector Colony, Chembur East, Mumbai -  
400074.  
Tel: 022 61532 500  
Email: [m.vijayalakshmi@ves.ac.in](mailto:m.vijayalakshmi@ves.ac.in)  
Email: [shanta.sondur@ves.ac.in](mailto:shanta.sondur@ves.ac.in)

## IX. Limitation on the liability

Given the non-financial nature of the agreement, and the dependency on the success of this collaboration, no party is liable in any way.

Vivekanand Education Society's  
Institute of Technology  
Hashu Advani Memorial Complex,  
Collector Colony, Chembur,  
Mumbai-400 074 INDIA

Scanned with CamScanner



# Vivekanand Education Society's Institute of Technology

(Affiliated to University of Mumbai, Approved by AICTE & Recognized by Govt. of Maharashtra)

-213

**X. Termination**  
Both parties can terminate this MoU in writing to the other party with thirty days' notice.

**XI. Variation**  
The terms of this Memorandum of Understanding may be amended or modified with the mutual consent in writing of both parties.

**XII. Force Majeure**  
Any delay or failure in fulfilling the responsibilities as stated in Clauses II/III shall be excused if and to the extent caused by the occurrence of a Force Majeure. For purposes of this MoU, Force Majeure shall mean a cause or event that is not reasonably foreseeable or otherwise caused by or under the control of the Party claiming Force Majeure, including acts of God, fires, floods, explosions, riots, wars, hurricane, sabotage terrorism, vandalism, accident and other like events that are beyond the reasonable anticipation and control of any or all of the parties affected thereby, despite the party's reasonable efforts to prevent, avoid, delay, or mitigate the effect of such acts, events or occurrences, and which events or the effects thereof are not attributable to the party's failure to perform its obligations under this MoU.

For and on behalf of  
Municipal Corporation of Greater Mumbai.

Mr.   
Anand L. Wagaralkar  
Jt. Municipal Commissioner (Solid Waste Management)

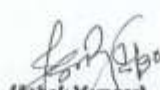
  
Ashok Yargar  
Chief Engineer  
(Solid Waste Management)

For and on behalf of  
Vivekanand Education Society's Institute of Technology's Department of  
Information Technology.

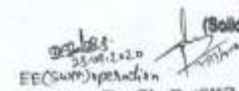
  
Dr. (Mrs.) M. Vijayalakshmi  
Vice-Principal

  
P. N. Hirrat  
NOTARY  
MUMBAI  
REG. SOLID TIR  
GOVT.













NOTARY  
2021/2020  
09 SEP 2020  
082

Vivekanand Education Society's  
Institute of Technology  
Hastru Adnan Memorial Campus,  
Collector Colony, Chembur,  
Mumbai-400 074 INDIA



### Annexure 2

Swechcha Project shall include the scope of services of VESIT-IT as specifically mention in the MOU executed between Municipal corporation of Greater Mumbai & Vivekanand Education Society's Institute of Technology and also captured in below table:

Sr. No.	Item	Category	Recurring	Unit Cost	Unit Count (INR)	Total Cost for 2 years	Remarks
1	Development Cost (for first version): 5 Faculties investing approx 200 Hours	Development	No	1,000	200	2,00,000	
2	Workshops: Training to M(E) ward approx 800 people in slots of 50 each. Including Hospitality	Training	Yes	16	10000	1,60,000	Approx 1000 CTs & 1000 PTs Training for 2 person per CT/PT Training for 4000 persons in 3 years Slot of 100 persons, so 40 sessions (slots)
3	Computers for Data Back Up, Development and Testing the services.	Infrastructure	No	75,000	2	1,50,000	
4	Data Centre Dedicated Server Room in VESIT (Cost of Furnishing, Electrical Fittings, ACs)	Infrastructure	No	1,00,000	1	1,00,000	
5	Dedicated Server Room in VESIT (Networking: Equipment, Cabling and fitting)	Infrastructure	No	50,000	1	50,000	
6	Surveys	Development	Yes	50,000	1	50,000	
7	Dedicated Server hosted at a Leading Hosting Service Provider (Charge for 1 Year)	Deployment	Yes	1,00,000	2	2,00,000	
8	Support: 3 Faculties investing approx 200 Hours after Development	Support	Yes	800	200	1,60,000	
9	Internet charges for Server Room Per year cost, Sharing Basis	Infrastructure	Yes	30,000	1	30,000	
10	Project Staff Charges	Development and Training	Yes	50,000	24	12,00,000	
11	Miscellaneous	-	-	-	-	1,00,000	
<b>Total</b>						<b>24,00,000</b>	





# Vivekanand Education Society's Institute of Technology

(Affiliated to University of Mumbai, Approved by AICTE & Recognized by Govt. of Maharashtra)

## Annexure 3

### Schedule of remitting Financial Support

Sr No.	Period	Total Amount (INR)
1	Dec 20-Mar 21	6,05,000
2	April-June 21	3,60,000
3	July-Sept 21	2,85,000
4	Oct-Dec 21	2,85,000
5	Jan-Mar 22	2,95,000
6	Jan-Mar 22	2,95,000
7	July-Sep 22	2,95,000
<b>Total</b>		<b>24,00,000</b>
<b>In words</b>		<b>Rupees Twenty-Four Lakh Only</b>







Since 1962

# Vivekanand Education Society's Institute of Technology

(Affiliated to University of Mumbai, Approved by AICTE & Recognized by Govt. of Maharashtra)

Annexure 4

Logo of SUD Life



## Star Union Dai-ichi Life Insurance

A joint venture of

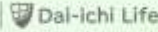
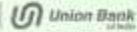
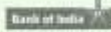

M. Vijaya





# Vivekanand Education Society's Institute of Technology

Since 1962

(Affiliated to University of Mumbai, Approved by AICTE & Recognized by Govt. of Maharashtra)



Lifna C S <lifna.cs@ves.ac.in>

**Fwd: Microsoft AI for Earth Grant Decision ID:00010000186**

2 messages

Sharmila Sengupta <sharmila.sengupta@ves.ac.in>  
To: Lifna C S <lifna.cs@ves.ac.in>

Sat, Nov 28, 2020 at 12:04 AM

----- Forwarded message -----

From: **Pooja Nagdev** <pooja.nagdev@ves.ac.in>  
Date: Sat, 28 Nov 2020, 00:03  
Subject: Fwd: Microsoft AI for Earth Grant Decision ID:00010000186  
To: Sharmila Sengupta <sharmila.sengupta@ves.ac.in>

----- Forwarded message -----

From: **AI for Earth Grant Support** <ai4earth@microsoft.com>  
Date: Tue, 20 Oct 2020, 19:10  
Subject: Microsoft AI for Earth Grant Decision ID:00010000186  
To: Pooja Nagdev <pooja.nagdev@ves.ac.in>



Dear Pooja Nagdev,

Congratulations, and welcome to the AI for Earth community! We are excited to share that your application for the project titled "Monitoring and Assessing Coral Reefs in Oceans" has been selected for an AI for Earth Microsoft Azure Compute Grant. Through this award, you will receive a sponsored Microsoft Azure account. We are granting you credits for Azure consumption up to \$5000 USD, to be utilized within one year.

By accepting this award, you agree to the following terms:

- You will use Microsoft Azure credits awarded through this program only towards the project described in the application form.
- Microsoft will add you and your team members to resources including the AI for Earth grantee community website, AI for Earth grantee Microsoft Teams group, and digital events.
- You will submit a mid-term report and a final report according to AI for Earth guidelines.
- Microsoft may contact you and use materials that you submit for public communications.

**Please accept this grant within one week of receiving this email** by clicking "Accept Your Grant" on your [grant portal](#) home page. We will respond when you accept with next steps to access the onboarding webinar, sponsored Azure credits, and education resources.

Warmly,

**Bonnie Lei**  
AI for Earth Grants Manager

Microsoft respects your privacy. Review our online [Privacy Statement](#).  
Microsoft Corporation  
One Microsoft Way

antsp

Redmond, WA, USA 98052



Pooja Nagdev <pooja.nagdev@ves.ac.in>  
To: Lifna C S <lifna.cs@ves.ac.in>

Wed, May 5, 2021 at 3:50 PM

----- Forwarded message -----

From: **AI for Earth Grant Support** <ai4earth@microsoft.com>  
Date: Tue, 20 Oct 2020, 19:10  
Subject: Microsoft AI for Earth Grant Decision ID:00010000186  
To: Pooja Nagdev <pooja.nagdev@ves.ac.in>



Since 1962

# Vivekanand Education Society's Institute of Technology

(Affiliated to University of Mumbai, Approved by AICTE & Recognized by Govt. of Maharashtra)



Lifna C S <lifna.cs@ves.ac.in>

## Fwd: NC for SHORT TERM RESEARCH PROJECTS: FINANCIAL ASSISTANCE SCHEME – 2020-2021

2 messages

Nupur Giri <nupur.giri@ves.ac.in>  
To: Lifna C S <lifna.cs@ves.ac.in>

Tue, Sep 7, 2021 at 9:21 AM

----- Forwarded message -----

From: Nupur Giri <nupur.giri@ves.ac.in>

Date: Tue, 29 Sep 2020 at 3:55 PM

Subject: NC for SHORT TERM RESEARCH PROJECTS: FINANCIAL ASSISTANCE SCHEME – 2020-2021

To: J M Nair <principal.vesit@ves.ac.in>, Vikas Pange <vikas.pange@ves.ac.in>

Dear Madam,

I am happy to notify that during lockdown I had send a **short term proposal research proposal** to THE TUBERCULOSIS ASSOCIATION OF INDIA, New Delhi titled "**ARTIFICIAL INTELLIGENCE MODEL FOR EPIDEMIOLOGY OF TUBERCULOSIS**" which has been approved for grant of financial assistance of **Rs.30,000/- (Rupees Thirty Thousand Only)**.

To complete the formalities I request you to kindly grant NOC for the same.

The project Proposal and the NOC format is attached herewith.

Thanks for all the motivation and support

Warm Regards

----- Forwarded message -----

From: tbassnindia@yahoo.co.in <tbassnindia@yahoo.co.in>

Date: Mon, Sep 21, 2020 at 2:17 PM

Subject: SHORT TERM RESEARCH PROJECTS: FINANCIAL ASSISTANCE SCHEME – 2020-2021

To: nupur.giri@ves.ac.in <nupur.giri@ves.ac.in>

Dear Dr. Nupur,

We are pleased to inform you that your research project titled "**ARTIFICIAL INTELLIGENCE MODEL FOR EPIDEMIOLOGY OF TUBERCULOSIS**" has been approved for grant of financial assistance of Rs.30,000/- (Rupees Thirty Thousand Only).

You may send your consent to undertake the Research Project. If you have not forwarded the proposal through proper channel, may please submit the permission of the Head of the Department/Institution where you intend to conduct the research. Only on receipt of your consent and "No Objection Certificate" from the competent authority, the financial assistance will be released.

With good wishes,

(Subhash Chand Khatri)  
Secretary General

—  
Dr. Nupur Giri,  
Professor & HOD,



## THE TUBERCULOSIS ASSOCIATION OF INDIA

### "SHORT TERM RESEARCH PROJECTS": FINANCIAL ASSISTANCE SCHEME - 2020-2021

The following projects have been approved for funding during this year. The amount approved and other details are being communicated in letters to the individual Researchers.

1. "A study on challenges in implementing artificial intelligence in diagnosing and managing respiratory diseases in tertiary health care setting in Tamilnadu".

**Dr. S. Sangeetha, V.M.K.V. Medical College & Hospital, Salem**

2. "A comparative study on nutritional status, hematological & biochemical parameters among elderly population with & without pulmonary tuberculosis in a tertiary health care hospital in Ghaziabad dist, India"

**Dr. Juhi Aggarwal, Santosh Medical College & Hospital, Ghaziabad**

3. "Identifying gaps in obtaining samples in Presumptive pediatrics pulmonary TB cases and obtaining solutions in selected districts of Telangana"

**Dr. C. Sumalata, STDC, Hyderabad**

4. "ARTIFICIAL INTELLIGENCE MODEL FOR EPIDEMIOLOGY OF TUBERCULOSIS"

**Dr. (Mrs.) Nupur Giri, VES Institute of Technology, Chembur**

5. "Applications of nanotechnology for smear-negative tuberculosis diagnosis in resource-limited settings: A study from Warangal."

**Dr. Malathi Jojula, Sri Shivani College of Pharmacy, Warangal**

6. "Spirometry as a tool to motivate smoking cessation- An intervention Study"

**Dr. K. Hemalatha, Trichy SRM Medical College Hospital and Research Centre, Tamil Nadu**

7. "Assessing physical and chemical properties of saliva among tuberculosis patients on anti-tuberculosis treatment- An observational study"

**Dr. Vidya G Doddawad, JSS Dental College and Hospital, Mysuru**

8. "Vulnerability mapping for pulmonary tuberculosis among elderly receiving palliative care in Cochin corporation."

**Dr. Sambhu Ramesh, Amrita Institute of Medical Sciences and Research Centre, Kerala**





# Vivekanand Education Society's Institute of Technology

(Affiliated to University of Mumbai, Approved by AICTE & Recognized by Govt. of Maharashtra)

5/10/2021

Welcome to Vivekanand Education Society Mail - Fwd: Welcome to the Microsoft AI for Earth Community - Azure Compute



Bincy Chellapandi <2018.bincy.chellapandi@ves.ac.in>

## Fwd: Welcome to the Microsoft AI for Earth Community - Azure Compute

1 message

Sukanya Roychowdhury <sukanya.roychowdhury@ves.ac.in>  
To: 2018.bincy.chellapandi@ves.ac.in

Mon, May 10, 2021 at 2:13 PM

----- Forwarded message -----

From: **AI for Earth Grant Support** <ai4ehelp@microsoft.com>  
Date: Sat, 25 Jan, 2020, 1:43 am  
Subject: Welcome to the Microsoft AI for Earth Community - Azure Compute  
To: sukanya.roychowdhury@ves.ac.in <sukanya.roychowdhury@ves.ac.in>

cid:image001.png@01D590C0.6D355530

Dear Roychowdhury, Sukanya:

Congratulations, and welcome to the AI for Earth community! We are excited to share that your application for the project titled "Forest Fire Prediction using Machine Learning and AI for the Indian Subcontinent," has been selected for an AI for Earth Microsoft Azure Compute Grant. Through this award, you will receive a sponsored Microsoft Azure account. We are granting you credits for Azure consumption up to \$15000 USD, to be utilized within one year.

By accepting this award, you agree to the following terms:

- You will submit a mid-term report and a final report according to AI for Earth guidelines
- Microsoft may use materials (or summaries of those materials) that you submit as part of the application, mid-term report, and final report for public communications, including Microsoft websites (including use of your organization's trademarks and logos)
- Microsoft may contact you and your team members for additional information on your project
- You will attend a mandatory onboarding webinar on February 4, either 8am or 8pm PST.

**Please accept this award by January 31, 5pm PST through this link.** We will respond when you accept with next steps to access the onboarding webinars, sponsored Azure credits, and education resources.

Bonnie Lei

AI for Earth  
Environmental Sustainability

Microsoft respects your privacy. Review our online Privacy Statement

Microsoft Corporation

One Microsoft Way

Redmond, WA, USA 98052

cid:image002.png@01D590C0.6D355530

2 attachments

https://mail.google.com/mail/u/0/?ik=687cf3d8d3&view=pt&search=all&permthid=thread-f%3A1699360247254501020&siml=msg-f%3A16993602... 1/2



# Vivekanand Education Society's Institute of Technology

(Affiliated to University of Mumbai, Approved by AICTE & Recognized by Govt. of Maharashtra)

5/12/2021

Welcome to Vivekanand Education Society Mail - Fwd: Welcome to the AI for Earth Community



Bincy Chellapandi <2018.bincy.chellapandi@ves.ac.in>

## Fwd: Welcome to the AI for Earth Community

1 message

Jayashree hajgude <jayashree.hajgude@ves.ac.in>  
To: 2018.bincy.chellapandi@ves.ac.in

Tue, May 11, 2021 at 8:48 PM

----- Forwarded message -----

From: **SUMEDH GHAVAT** <2017.sumedh.ghavat@ves.ac.in>  
Date: Wed, May 6, 2020 at 2:47 AM  
Subject: Fwd: Welcome to the AI for Earth Community  
To: HARSHITA SINGH <2017.harshita.singh@ves.ac.in>, Jayashree hajgude <jayashree.hajgude@ves.ac.in>, PARTH KODNANI <2017.parth.kodnani@ves.ac.in>

----- Forwarded message -----

From: **AI for Earth Grant Support** <ai4ehelp@microsoft.com>  
Date: Wed, 6 May 2020 at 02:40  
Subject: Welcome to the AI for Earth Community  
To: 2017.sumedh.ghavat@ves.ac.in <2017.sumedh.ghavat@ves.ac.in>  
Cc: AI for Earth Grant Support <ai4ehelp@microsoft.com>



Dear Sumedh D Ghavat,

Congratulations, and welcome to the AI for Earth community! We are excited to share that your project titled "Land Use Classification Using Satellite Images" has been awarded an AI for Earth Microsoft Azure Compute Grant. Through this award, you will receive a sponsored Microsoft Azure account. We are granting you credits for Azure consumption up to 15,000 USD, to be utilized within one year.

Please follow these next steps:

- Accept this award by May 9th, 5pm PST through this [link](#). The sooner you accept, the sooner we can get your account Azure account created
- Activate your Azure account by following the instructions in the email from [azure-noreply@microsoft.com](mailto:azure-noreply@microsoft.com) with the subject "Welcome to Azure Sponsorship...". If you do not receive the email within 48 hours of doing step #1, contact [AI4EHelp@microsoft.com](mailto:AI4EHelp@microsoft.com).
- Attend one of the onboarding webinars by following the instructions you will receive shortly via email through calendar invites.
- Browse the [AI for Earth Community SharePoint site](#) where you can find information on how to get started on Azure and interact with other AI for Earth grantees on Teams. If more team members want access to this site, email [AI4EHelp@microsoft.com](mailto:AI4EHelp@microsoft.com).
- Share any plans you may have around amplifying your AI4E award (including media outreach, press release, social media, etc.) with [MSEnvironmentalSustainability@we-worldwide.com](mailto:MSEnvironmentalSustainability@we-worldwide.com).

**If you are nonprofit, academic, or start-up institution interested in accessing Esri software licenses, please follow the below instructions:**

Esri software licenses for ArcGIS Pro and ArcGIS Enterprise can be provided for the one year term of the grant. Please note:

- Award details will be determined by working with each grantee directly
- Your licenses will expire in one year
- Your use of the software is subject to the standard software licenses for the products.

<https://mail.google.com/mail/u/1/?ik=687cf3d8d3&view=pt&search=all&permthid=thread-f%3A1699475738498127192&siml=msg-f%3A16994757...> 1/2



# Vivekanand Education Society's Institute of Technology

(Affiliated to University of Mumbai, Approved by AICTE & Recognized by Govt. of Maharashtra)

5/12/2021

Welcome to Vivekanand Education Society Mail - Fwd: Welcome to the AI for Earth Community

**Next steps:**

- Please contact the appropriate representative to obtain access to the Esri Licensing award:
  - Educational Institutions please contact Michael Gould [MGould@esri.com](mailto:MGould@esri.com)
  - Nonprofit Organizations please contact Steve Beckwitt [SBeckwitt@esri.com](mailto:SBeckwitt@esri.com)
  - Start-up Institutions please contact [startups@esri.com](mailto:startups@esri.com)
- If you already have access to Esri technology through an existing agreement, Esri will facilitate license distribution from the Educational Site License or Nonprofit Enterprise Agreement administrator.
- If you need access to Esri licenses, complimentary term licenses for ArcGIS Professional and ArcGIS Enterprise will be provided by the Esri support contacts listed above.

**Bonnie Lei**

Head of Global Strategic Partnerships



Microsoft respects your privacy. Review our online Privacy Statement.

Microsoft Corporation

One Microsoft Way

Redmond, WA, USA 98052







# Vivekanand Education Society's Institute of Technology

(Affiliated to University of Mumbai, Approved by AICTE & Recognized by Govt. of Maharashtra)

Fwd: Microsoft AI for Earth Grant Decision ID:00010003308 External



Narayani Patil <narayenipatil99@gmail.com>  
to: M. me, shubhamika2302 <>

----- Forwarded message -----

From: AI for Earth Grant Support <[ai4earth@microsoft.com](mailto:ai4earth@microsoft.com)>  
Date: Wed, 3 Feb 2021, 12:23 pm  
Subject: Microsoft AI for Earth Grant Decision ID:00010003308  
To: Narayani Patil <[narayenipatil99@gmail.com](mailto:narayenipatil99@gmail.com)>



Dear Narayani Patil,

Congratulations, and welcome to the AI for Earth community! We are excited to share that your application for the project titled "AI based Farmer Empowerment" has been selected for an AI for Earth Microsoft Azure Compute Grant. Through this award, you will receive a sponsored Microsoft Azure account. We are granting you credits for Azure consumption up to \$10000 USD, to be utilized within one year.

By accepting this award, you agree to the following terms:

- You will use Microsoft Azure credits awarded through this program only towards the project described in the application form.
- Microsoft will assist you and your team members to resources including the AI for Earth grantee community website, AI for Earth grantee Microsoft Teams group, and digital events.
- You will submit a mid-term report and a final report according to AI for Earth guidelines.
- Microsoft may contact you and use materials that you submit for public communications.

Please accept this grant within one week of receiving this email by clicking "Accept Your Grant" on your [grantportal](https://grantportal.azure.com) home page. We will respond when you accept with next steps to access the onboarding webinar, sponsored Azure credits, and education resources.

Warmly,

[Bonnie Lei](#)

AI for Earth Grants Manager

Microsoft respects your privacy. [Review our online Privacy Statement](#)

Microsoft Corporation  
One Microsoft Way

Redmond, WA, USA 98032





# Vivekanand Education Society's Institute of Technology

Since 1962

(Affiliated to University of Mumbai, Approved by AICTE & Recognized by Govt. of Maharashtra)

## स्वदेशी MICROPROCESSOR CHALLENGE

### LIST OF 100 SEMI-FINALISTS

Sl No.	Registration Number	Team	Project Title	Category	Registration Type	Presented Team	IPR/ Award Type
1	799180	MANU LADU (PIITM)	"Tree", "codium" using "Infrared Micro-sensor"	Team	Start-up	SMART Page (204-4180)	Airtel-2007
2	799181	Tanvir Bhatnagar	Smart - Smart Device Solution for Smart Life	Team	Start-up	SMART Page (211-4351)	Airtel-2007
3	800460	Singara Development Partner	Design and Development of SmartWatches for Biomedical Applications	Team	Educational Institute	SMART Page (210-4306)	Airtel-2007
4	801411	Vijaykumar Subramanian	SmartCity's Smart Vehicle Japan (SVJ)	Team	Start-up	SMART Page (204-4180)	Airtel-2007
5	802611	Prashant K L	IoT for Agriculture	Team	Start-up	SMART Page (211-4351)	Airtel-2007
6	874120	Aayush	SMART AND DEVELOPMENT OF SMART WEARABLE AIR QUALITY SENSOR - "SMART AQAR"	Team	Educational Institute	SMART Page (203-4130)	Airtel-2007
7	874121	Arshi Mishra	Autonomous	Individual	Start-up	VEGA 4110K1	Airtel-2007
8	874122	Prashant K P	Electronic Scales for Quality Improved	Team	Educational Institute	VEGA 4110K1	Airtel-2007
9	874123	Pratik Srinivas M	Project of IoT/Blockchain - tracking Utility Wide Band connections	Individual	Other	SMART Page (204-4180)	Airtel-2007
10	874124	Vijayesh D	IoT Controller	Team	Start-up	SMART Page (204-4180)	Airtel-2007
11	874125	Anurag Kishan R	Smart Agriculture	Team	Educational Institute	SMART Page (204-4180)	Airtel-2007
12	874126	Shantanu S	Software Defined Control Powerline Router	Team	Other	SMART Page (204-4180)	Airtel-2007
13	874127	Aravind Kumar/Krishan	Water Smart Meter based on Internet of Medical Things	Team	Other	SMART Page (202-4000)	Airtel-2007
14	880045	Pa B. Bharath	INDIAN - Indigenous Hand-Support of Alzheimer's IT Development Platform	Team	Start-up	VEGA 4110K1	Airtel-2007
15	881171	Prasad Phadnis	Photochemical Workstation for Scientific Research and Teaching	Individual	Other	VEGA 4110K1	Airtel-2007
16	881172	Arjun Karjane	Fault Tolerant Reliable Integrated Analysis System for Smart	Team	Start-up	VEGA 4110K1	Airtel-2007
17	881225	Sankul Ran	Smart Road Traffic Monitoring and Control System	Team	Educational Institute	VEGA 4110K1	Airtel-2007
18	881242	Arjun Acharya	NAVE-GIS based protocol for Fire Evacuation Navigation Solution	Team	Other	SMART Page (210-4306)	Airtel-2007
19	881251	Shreyash Chavan	DSM: Digital Information for Diagnostic and Analysis is applied to electrical and electronic circuits of automobile vehicles	Team	Start-up	SMART Page (210-4306)	Airtel-2007
20	881265	Siddhant Joshi	IoT and AI Enabled Smart Farm Substation Diagnostics and	Team	Start-up	SMART Page (210-4306)	Airtel-2007
21	881283	Rishi Surt	IoT enabled Battery Management System for marine and accurate Battery State and Health Monitoring (airating)	Team	Educational Institute	SMART Page (204-4180)	Airtel-2007
22	881284	Rishi Surt	IoT enabled Battery Management System for marine and accurate Battery State and Health Monitoring (airating)	Team	Educational Institute	SMART Page (204-4180)	Airtel-2007
23	881285	Rishi Surt	IoT enabled Battery Management System for marine and accurate Battery State and Health Monitoring (airating)	Team	Educational Institute	SMART Page (204-4180)	Airtel-2007
24	881286	Arjun L N	IoT Based Fire Storage Monitoring and AI based Fire Sprinkler Control System	Team	Start-up	SMART Page (210-4306)	Airtel-2007
25	881287	Arjun L N	IoT Based Fire Storage Monitoring and AI based Fire Sprinkler Control System	Team	Start-up	SMART Page (210-4306)	Airtel-2007
26	881288	Arjun L N	IoT Based Fire Storage Monitoring and AI based Fire Sprinkler Control System	Team	Start-up	SMART Page (210-4306)	Airtel-2007
27	881289	Arjun L N	IoT Based Fire Storage Monitoring and AI based Fire Sprinkler Control System	Team	Start-up	SMART Page (210-4306)	Airtel-2007
28	881290	Arjun L N	IoT Based Fire Storage Monitoring and AI based Fire Sprinkler Control System	Team	Start-up	SMART Page (210-4306)	Airtel-2007
29	881291	Arjun L N	IoT Based Fire Storage Monitoring and AI based Fire Sprinkler Control System	Team	Start-up	SMART Page (210-4306)	Airtel-2007
30	881292	Arjun L N	IoT Based Fire Storage Monitoring and AI based Fire Sprinkler Control System	Team	Start-up	SMART Page (210-4306)	Airtel-2007
31	881293	Arjun L N	IoT Based Fire Storage Monitoring and AI based Fire Sprinkler Control System	Team	Start-up	SMART Page (210-4306)	Airtel-2007
32	881294	Arjun L N	IoT Based Fire Storage Monitoring and AI based Fire Sprinkler Control System	Team	Start-up	SMART Page (210-4306)	Airtel-2007
33	881295	Arjun L N	IoT Based Fire Storage Monitoring and AI based Fire Sprinkler Control System	Team	Start-up	SMART Page (210-4306)	Airtel-2007
34	881296	Arjun L N	IoT Based Fire Storage Monitoring and AI based Fire Sprinkler Control System	Team	Start-up	SMART Page (210-4306)	Airtel-2007
35	881297	Arjun L N	IoT Based Fire Storage Monitoring and AI based Fire Sprinkler Control System	Team	Start-up	SMART Page (210-4306)	Airtel-2007
36	881298	Arjun L N	IoT Based Fire Storage Monitoring and AI based Fire Sprinkler Control System	Team	Start-up	SMART Page (210-4306)	Airtel-2007
37	881299	Arjun L N	IoT Based Fire Storage Monitoring and AI based Fire Sprinkler Control System	Team	Start-up	SMART Page (210-4306)	Airtel-2007
38	881300	Arjun L N	IoT Based Fire Storage Monitoring and AI based Fire Sprinkler Control System	Team	Start-up	SMART Page (210-4306)	Airtel-2007
39	881301	Arjun L N	IoT Based Fire Storage Monitoring and AI based Fire Sprinkler Control System	Team	Start-up	SMART Page (210-4306)	Airtel-2007
40	881302	Arjun L N	IoT Based Fire Storage Monitoring and AI based Fire Sprinkler Control System	Team	Start-up	SMART Page (210-4306)	Airtel-2007
41	881303	Arjun L N	IoT Based Fire Storage Monitoring and AI based Fire Sprinkler Control System	Team	Start-up	SMART Page (210-4306)	Airtel-2007
42	881304	Arjun L N	IoT Based Fire Storage Monitoring and AI based Fire Sprinkler Control System	Team	Start-up	SMART Page (210-4306)	Airtel-2007
43	881305	Arjun L N	IoT Based Fire Storage Monitoring and AI based Fire Sprinkler Control System	Team	Start-up	SMART Page (210-4306)	Airtel-2007
44	881306	Arjun L N	IoT Based Fire Storage Monitoring and AI based Fire Sprinkler Control System	Team	Start-up	SMART Page (210-4306)	Airtel-2007
45	881307	Arjun L N	IoT Based Fire Storage Monitoring and AI based Fire Sprinkler Control System	Team	Start-up	SMART Page (210-4306)	Airtel-2007
46	881308	Arjun L N	IoT Based Fire Storage Monitoring and AI based Fire Sprinkler Control System	Team	Start-up	SMART Page (210-4306)	Airtel-2007
47	881309	Arjun L N	IoT Based Fire Storage Monitoring and AI based Fire Sprinkler Control System	Team	Start-up	SMART Page (210-4306)	Airtel-2007
48	881310	Arjun L N	IoT Based Fire Storage Monitoring and AI based Fire Sprinkler Control System	Team	Start-up	SMART Page (210-4306)	Airtel-2007
49	881311	Arjun L N	IoT Based Fire Storage Monitoring and AI based Fire Sprinkler Control System	Team	Start-up	SMART Page (210-4306)	Airtel-2007
50	881312	Arjun L N	IoT Based Fire Storage Monitoring and AI based Fire Sprinkler Control System	Team	Start-up	SMART Page (210-4306)	Airtel-2007
51	881313	Arjun L N	IoT Based Fire Storage Monitoring and AI based Fire Sprinkler Control System	Team	Start-up	SMART Page (210-4306)	Airtel-2007
52	881314	Arjun L N	IoT Based Fire Storage Monitoring and AI based Fire Sprinkler Control System	Team	Start-up	SMART Page (210-4306)	Airtel-2007
53	881315	Arjun L N	IoT Based Fire Storage Monitoring and AI based Fire Sprinkler Control System	Team	Start-up	SMART Page (210-4306)	Airtel-2007
54	881316	Arjun L N	IoT Based Fire Storage Monitoring and AI based Fire Sprinkler Control System	Team	Start-up	SMART Page (210-4306)	Airtel-2007
55	881317	Arjun L N	IoT Based Fire Storage Monitoring and AI based Fire Sprinkler Control System	Team	Start-up	SMART Page (210-4306)	Airtel-2007
56	881318	Arjun L N	IoT Based Fire Storage Monitoring and AI based Fire Sprinkler Control System	Team	Start-up	SMART Page (210-4306)	Airtel-2007
57	881319	Arjun L N	IoT Based Fire Storage Monitoring and AI based Fire Sprinkler Control System	Team	Start-up	SMART Page (210-4306)	Airtel-2007
58	881320	Arjun L N	IoT Based Fire Storage Monitoring and AI based Fire Sprinkler Control System	Team	Start-up	SMART Page (210-4306)	Airtel-2007
59	881321	Arjun L N	IoT Based Fire Storage Monitoring and AI based Fire Sprinkler Control System	Team	Start-up	SMART Page (210-4306)	Airtel-2007
60	881322	Arjun L N	IoT Based Fire Storage Monitoring and AI based Fire Sprinkler Control System	Team	Start-up	SMART Page (210-4306)	Airtel-2007
61	881323	Arjun L N	IoT Based Fire Storage Monitoring and AI based Fire Sprinkler Control System	Team	Start-up	SMART Page (210-4306)	Airtel-2007
62	881324	Arjun L N	IoT Based Fire Storage Monitoring and AI based Fire Sprinkler Control System	Team	Start-up	SMART Page (210-4306)	Airtel-2007
63	881325	Arjun L N	IoT Based Fire Storage Monitoring and AI based Fire Sprinkler Control System	Team	Start-up	SMART Page (210-4306)	Airtel-2007
64	881326	Arjun L N	IoT Based Fire Storage Monitoring and AI based Fire Sprinkler Control System	Team	Start-up	SMART Page (210-4306)	Airtel-2007
65	881327	Arjun L N	IoT Based Fire Storage Monitoring and AI based Fire Sprinkler Control System	Team	Start-up	SMART Page (210-4306)	Airtel-2007
66	881328	Arjun L N	IoT Based Fire Storage Monitoring and AI based Fire Sprinkler Control System	Team	Start-up	SMART Page (210-4306)	Airtel-2007
67	881329	Arjun L N	IoT Based Fire Storage Monitoring and AI based Fire Sprinkler Control System	Team	Start-up	SMART Page (210-4306)	Airtel-2007
68	881330	Arjun L N	IoT Based Fire Storage Monitoring and AI based Fire Sprinkler Control System	Team	Start-up	SMART Page (210-4306)	Airtel-2007
69	881331	Arjun L N	IoT Based Fire Storage Monitoring and AI based Fire Sprinkler Control System	Team	Start-up	SMART Page (210-4306)	Airtel-2007
70	881332	Arjun L N	IoT Based Fire Storage Monitoring and AI based Fire Sprinkler Control System	Team	Start-up	SMART Page (210-4306)	Airtel-2007
71	881333	Arjun L N	IoT Based Fire Storage Monitoring and AI based Fire Sprinkler Control System	Team	Start-up	SMART Page (210-4306)	Airtel-2007
72	881334	Arjun L N	IoT Based Fire Storage Monitoring and AI based Fire Sprinkler Control System	Team	Start-up	SMART Page (210-4306)	Airtel-2007
73	881335	Arjun L N	IoT Based Fire Storage Monitoring and AI based Fire Sprinkler Control System	Team	Start-up	SMART Page (210-4306)	Airtel-2007
74	881336	Arjun L N	IoT Based Fire Storage Monitoring and AI based Fire Sprinkler Control System	Team	Start-up	SMART Page (210-4306)	Airtel-2007
75	881337	Arjun L N	IoT Based Fire Storage Monitoring and AI based Fire Sprinkler Control System	Team	Start-up	SMART Page (210-4306)	Airtel-2007
76	881338	Arjun L N	IoT Based Fire Storage Monitoring and AI based Fire Sprinkler Control System	Team	Start-up	SMART Page (210-4306)	Airtel-2007
77	881339	Arjun L N	IoT Based Fire Storage Monitoring and AI based Fire Sprinkler Control System	Team	Start-up	SMART Page (210-4306)	Airtel-2007
78	881340	Arjun L N	IoT Based Fire Storage Monitoring and AI based Fire Sprinkler Control System	Team	Start-up	SMART Page (210-4306)	Airtel-2007
79	881341	Arjun L N	IoT Based Fire Storage Monitoring and AI based Fire Sprinkler Control System	Team	Start-up	SMART Page (210-4306)	Airtel-2007
80	881342	Arjun L N	IoT Based Fire Storage Monitoring and AI based Fire Sprinkler Control System	Team	Start-up	SMART Page (210-4306)	Airtel-2007
81	881343	Arjun L N	IoT Based Fire Storage Monitoring and AI based Fire Sprinkler Control System	Team	Start-up	SMART Page (210-4306)	Airtel-2007
82	881344	Arjun L N	IoT Based Fire Storage Monitoring and AI based Fire Sprinkler Control System	Team	Start-up	SMART Page (210-4306)	Airtel-2007
83	881345	Arjun L N	IoT Based Fire Storage Monitoring and AI based Fire Sprinkler Control System	Team	Start-up	SMART Page (210-4306)	Airtel-2007
84	881346	Arjun L N	IoT Based Fire Storage Monitoring and AI based Fire Sprinkler Control System	Team	Start-up	SMART Page (210-4306)	Airtel-2007
85	881347	Arjun L N	IoT Based Fire Storage Monitoring and AI based Fire Sprinkler Control System	Team	Start-up	SMART Page (210-4306)	Airtel-2007
86	881348	Arjun L N	IoT Based Fire Storage Monitoring and AI based Fire Sprinkler Control System	Team	Start-up	SMART Page (210-4306)	Airtel-2007
87	881349	Arjun L N	IoT Based Fire Storage Monitoring and AI based Fire Sprinkler Control System	Team	Start-up	SMART Page (210-4306)	Airtel-2007
88	881350	Arjun L N	IoT Based Fire Storage Monitoring and AI based Fire Sprinkler Control System	Team	Start-up	SMART Page (210-4306)	Airtel-2007
89	881351	Arjun L N	IoT Based Fire Storage Monitoring and AI based Fire Sprinkler Control System	Team	Start-up	SMART Page (210-4306)	Airtel-2007
90	881352	Arjun L N	IoT Based Fire Storage Monitoring and AI based Fire Sprinkler Control System	Team	Start-up	SMART Page (210-4306)	Airtel-2007
91	881353	Arjun L N	IoT Based Fire Storage Monitoring and AI based Fire Sprinkler Control System	Team	Start-up	SMART Page (210-4306)	Airtel-2007
92	881354	Arjun L N	IoT Based Fire Storage Monitoring and AI based Fire Sprinkler Control System	Team	Start-up	SMART Page (210-4306)	Airtel-2007
93	881355	Arjun L N	IoT Based Fire Storage Monitoring and AI based Fire Sprinkler Control System	Team	Start-up	SMART Page (210-4306)	Airtel-2007
94	881356	Arjun L N	IoT Based Fire Storage Monitoring and AI based Fire Sprinkler Control System	Team	Start-up	SMART Page (210-4306)	Airtel-2007
95	881357	Arjun L N	IoT Based Fire Storage Monitoring and AI based Fire Sprinkler Control System	Team	Start-up	SMART Page (210-4306)	Airtel-2007
96	881358	Arjun L N	IoT Based Fire Storage Monitoring and AI based Fire Sprinkler Control System	Team	Start-up	SMART Page (210-4306)	Airtel-2007
97	881359	Arjun L N	IoT Based Fire Storage Monitoring and AI based Fire Sprinkler Control System	Team	Start-up	SMART Page (210-4306)	Airtel-2007
98	881360	Arjun L N	IoT Based Fire Storage Monitoring and AI based Fire Sprinkler Control System	Team	Start-up	SMART Page (210-4306)	Airtel-2007
99	881361	Arjun L N	IoT Based Fire Storage Monitoring and AI based Fire Sprinkler Control System	Team	Start-up	SMART Page (210-4306)	Airtel-2007
100	881362	Arjun L N	IoT Based Fire Storage Monitoring and AI based Fire Sprinkler Control System	Team	Start-up	SMART Page (210-4306)	Airtel-2007



MINISTRY OF ELECTRONICS & INFORMATION TECHNOLOGY  
GOVERNMENT OF INDIA



myGov मेरी सरकार



# Vivekanand Education Society's Institute of Technology

(Affiliated to University of Mumbai, Approved by AICTE & Recognized by Govt. of Maharashtra)

## स्वदेशी MICROPROCESSOR CHALLENGE LIST OF 100 SEMI-FINALISTS

Sl No.	Registration Number	Name	Project Title	Category	Organization Type	Registration Type	PSMA Round Type
04	0000018	Pratik Khemut	Intelligent Disease Detection System for Automobiles	Team	Other	Smart (Private) (1) (1) (1) (1)	00001 (1)
07	0000020	Sulbhat Dhad	Predictive and adaptive learning methods enhanced with IoT devices which are developed for non-invasive access to wastewater targeting energy efficiency savings and water conservation in a residential home	Team	Start-up	00001 (1) (1) (1) (1)	00001 (1)
08	0000021	Madhupratim Chavan and Anshu Dabale	Intelligent Multi-Sensor Smart Light System for Smart City Applications	Team	Other	Smart (Vajra) (204-A) (200)	00001 (1)
09	0000024	Gayal R. Khat	Semi-Autonomous System for Traffic Monitoring and Identification of Traffic Violation Cases	Team	Educational Institution	VISA (00000)	00001 (1)
10	0000025	Jyotirmay Patil	SMARTEYE: Smart Eye Tracking System for User Experience Analysis	Team	Educational Institution	VISA (11000)	00001 (1)
11	0000026	Aditya Patil, Siddhant Patil	Customer System for Smart Home Security System	Individual	Other	Smart (Vajra) (1) (1) (1) (1)	00001 (1)
12	0000027	Sanjay P. Patil	IoT Based Smart Power Grid Monitoring and Controlling Plug	Team	Educational Institution	VISA (11000)	00001 (1)
13	0000028	Pratik Kulkarni	Intelligent Traffic Management System	Team	Educational Institution	Smart (Vajra) (204-A) (200)	00001 (1)
14	0000029	Mehul Kumar Prajapati	Image Sensing Robot	Team	Start-up	VISA (00000)	00001 (1)
15	0000030	Anand Karam Das	A System and Method for Remote Parking Slot Information Access	Team	Educational Institution	VISA (11000)	00001 (1)
16	0000031	Mayank Bhat	IoT Based Smart Home Security System	Team	Educational Institution	Smart (Vajra) (204-A) (200)	00001 (1)
17	0000032	Sudhakar Raj	Waste management	Team	Educational Institution	Smart (Vajra) (1) (1) (1) (1)	00001 (1)
18	0000033	DEEPIKASHREE SHARDA	SMART FILTRATION SYSTEM WITH AUTO-FLUSHING SYSTEM FOR WASTEWATER TREATMENT PLANTS	Individual	Educational Institution	Smart (Vajra) (204-A) (200)	00001 (1)
19	0000034	Manish Mishra	IoT Based Industry Management system	Team	Start-up	Smart (Private) (1) (1) (1) (1)	00001 (1)
20	0000035	Munish Mishra	IMPLEMENTATION OF SMART PROCESSOR IN GPS SATELLITE	Team	Other	Smart (Private) (1) (1) (1) (1)	00001 (1)
21	0000036	Raja J	Middleware Technology based Plug and Play application for industrial Process Control (PLC) based Technology	Team	Educational Institution	Smart (Vajra) (204-A) (200)	00001 (1)
22	0000037	Shagun Patil	SMART CONTROLLED LIGHTING SYSTEM	Team	Educational Institution	Smart (Vajra) (204-A) (200)	00001 (1)
23	0000038	PRASHANT MATHUR	Edge Computing Module for Image Processing	Team	Start-up	VISA (00000)	00001 (1)
24	0000039	Aravind Venkatesh B	Edge AI based Application of Predictive Maintenance Plug	Team	Other	Smart (Vajra) (204-A) (200)	00001 (1)
25	0000040	Shreyas S	Personalized Educational Content Recommendation	Team	Educational Institution	Smart (Private) (1) (1) (1) (1)	00001 (1)
26	0000041	Anand Kumar Sharma	A Multinational Biometric Queue and Robot for Checking and Waiting at Visitor Table	Team	Start-up	VISA (11000)	00001 (1)
27	0000042	Shreyas Hinge Ramesh	SMART WINDY POWER SYSTEM	Team	Educational Institution	Smart (Private) (1) (1) (1) (1)	00001 (1)
28	0000043	Tanish Kulkarni	Intelligent Traffic Management System	Team	Educational Institution	Smart (Vajra) (204-A) (200)	00001 (1)
29	0000044	Anshu Kulkarni	IoT Based Smart Home Security System	Team	Start-up	Smart (Private) (1) (1) (1) (1)	00001 (1)
30	0000045	Harshvardhan S	IoT Based Smart Home Security System	Team	Start-up	VISA (00000)	00001 (1)
31	0000046	Ashu Chavan	Next-generation AI smart robot with energy intelligence at Edge	Team	Start-up	Smart (Vajra) (204-A) (200)	00001 (1)
32	0000047	Sanjay Khatke	A product that provides feedback from being connected to TV from a hospital and can also be extended to providing treatment at home	Team	Start-up	VISA (11000)	00001 (1)
33	0000048	Pratik Dhad	Detection of Water Quality Infractions	Individual	Start-up	Edge (1) (1) (1) (1)	00001 (1)
34	0000049	Aravind Venkatesh B	YAMUNOBI CORE INTELLIGENCE (Cobots) - DESIGN & DEVELOPMENT OF IoT - Substation (IoT based) (IoT) Gateway - SMARTGRID 3	Individual	Other	Smart (Private) (1) (1) (1) (1)	00001 (1)
35	0000050	Nishant Arjun Patil	A portable real-time monitoring system for automatic water purification detection from smart sensors	Team	Educational Institution	VISA (00000)	00001 (1)
36	0000051	Aravind Venkatesh B	IMPACT of Automated Paper Double Round Round Time for Large Scale Printing	Team	Start-up	VISA (11000)	00001 (1)
37	0000052	Shashank Kulkarni	Camera Trap for Wildlife Monitoring and Surveillance in remote areas	Team	Start-up	Smart (Private) (1) (1) (1) (1)	00001 (1)
38	0000053	Dhishankh Patil	Internet-based Remote Control for Process Automation by Using VISA/Modbus Management Based Transmitters	Team	Other	VISA (00000)	00001 (1)
39	0000054	SHRIKANT BAPPAJI	IoT Based Smart Home Security System	Team	Educational Institution	Smart (Private) (1) (1) (1) (1)	00001 (1)
40	0000055	M. Vishal Khat	Robotic Learning System for Smart Plug for electrical meter (IoT) (IoT) (IoT) (IoT)	Team	Start-up	Smart (Private) (1) (1) (1) (1)	00001 (1)



# Vivekanand Education Society's Institute of Technology

(Affiliated to University of Mumbai, Approved by AICTE & Recognized by Govt. of Maharashtra)



Lekshmi Nair <leksa.alternate@gmail.com>

## Submission Received for स्वदेशी Microprocessor Challenge - Innovate Solutions for #आत्मनिर्भर भारत

1 message

**MyGov Team** <no-reply@mygov.in>  
To: leksa.alternate@gmail.com

Mon, Sep 7, 2020 at 10:41 PM

Dear Lekshmi Ajesh Kaimal,

Congratulations !!

You have successfully registered for स्वदेशी Microprocessor Challenge - Innovate Solutions for #आत्मनिर्भर भारत with  
Registration ID: 8820933

The registered Team has the following members:

Team Lead : Lekshmi Ajesh Kaimal  
Member 1 : Gopalakrishnan Narayanan  
Faculty 1 : Prakash P Vaidya

Please STAY TUNED for further instructions on next steps on or before 31st August 2020 on  
<https://innovate.mygov.in/>

Regards,  
Hardware Challenge and MyGov Team





# Vivekanand Education Society's Institute of Technology

(Affiliated to University of Mumbai, Approved by AICTE & Recognized by Govt. of Maharashtra)

8/27/2021

Certificate\_mentor\_ICDC.png

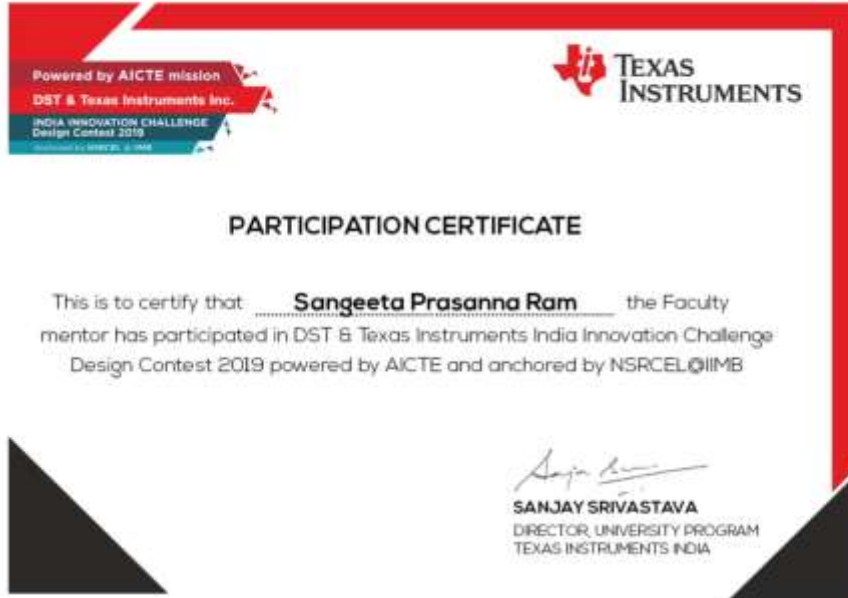

<https://mail.google.com/mail/u/0/#inbox/FMfgozGktOSZOPGHmRLJqtHwpNwxnG?projector=1&messagePartId=0.1>

1/1



# Vivekanand Education Society's Institute of Technology

(Affiliated to University of Mumbai, Approved by AICTE & Recognized by Govt. of Maharashtra)

8/26/2021

Welcome to Vivekanand Education Society Mail - Fwd: Team ID 1025233 , Cash Prize Details, IICDC Conclave 2019



Sangeeta PrasannaRam <sangeeta.prasannaram@ves.ac.in>

## Fwd: Team ID 1025233 , Cash Prize Details, IICDC Conclave 2019

ASHWIN PILLAY <2016.ashwin.pillay@ves.ac.in>  
To: Sangeeta PrasannaRam <sangeeta.prasannaram@ves.ac.in>

Thu, Aug 19, 2021 at 5:23 PM

----- Forwarded message -----

From: **ShaliniWings H.O** <fin-eve1@wingsevents.com>  
Date: Fri, 11 Jun, 2021, 7:53 pm  
Subject: Team ID 1025233 , Cash Prize Details, IICDC Conclave 2019  
To: <2016.ashwin.pillay@ves.ac.in>  
Cc: <x0290831@ti.com>, Alexy Kuriakose\Events\Wings H.O <alex@wingsevents.com>

Greetings from Texas Instruments!

Congratulations for being among the Top 60 Winning team of 'IICDC Conclave , DST & Texas Instruments (TI) Inc. India Innovation Challenge Design Contest 2019', anchored by the Indian Institute of Management (IIM), Bangalore.

It gives us great pleasure to notify that the Prize money won by you and your team has been credited into the Team Leader's account as per the details mentioned below.

**Cash Prize Amount** : Rs -19477/-  
**Prize amount transacted** : Rs- 13400/-  
**UTR number** : 106109679675  
**TDS @ 31.2%** : Rs -6077/-  
**Date transferred** :10.6.2021

**PS : Action Required** : Kindly acknowledge the receive in the Google form Link < <https://forms.gle/wCcLGybMBPz3iega9> > by 10<sup>th</sup> June 2021.

Regards,

Wings Event Management Team

(On Behalf of Texas Instruments University Program)



# Vivekanand Education Society's Institute of Technology

Since 1962

(Affiliated to University of Mumbai, Approved by AICTE & Recognized by Govt. of Maharashtra)



Government of India  
Department of Atomic Energy (DAE)  
Board of Research in Nuclear Sciences (BRNS)

BRNS Secretariat, 316/C,  
3rd Floor, BARC,  
Trombay, Mumbai-400085

No: 51/14/07/2019-BRNS/ 36083

Date: 10/07/2019

## OFFICE MEMORANDUM

Sub: R/P entitled "Development of Methodology for Indian Evaluated Nuclear Data Library for applications in S & T" under Dr.(Mrs.) Jayalekshmi M Nair, Principal, V.E.S. Institute of Technology, MUMBAI, Maharashtra, 400074, bearing sanction 51/14/07/2019-BRNS with NPP, BRNS.

On the recommendations of the Board of Research in Nuclear Sciences (BRNS), I am pleased to convey the administrative approval and sanction of the President of India for the captioned project for 3 years beginning from financial year 2019-2020 with a total grant of Rs. 17,81,276/- (Rupees seventeen lakh eighty one thousand two hundred seventy six only) for the project as under :

Item of expenditure	Year 1 (2019-2020)	Year 2 (2020-2021)	Year 3 (2021-2022)
Equipments	44500	0	0
Staff Salary - JRF (1)	372000	372000	420000
Technical Assistance	30000	30000	30000
Consumables	20000	20000	20000
Travel - PI	20000	20000	20000
Contingencies	50000	50000	50000
Overheads	36488	33150	36750
<b>Total(INR)</b>	<b>572988</b>	<b>525150</b>	<b>576750</b>

Note: \* Opti 5050 MT intel i5

JRF salary calculated @31,000/- p.m. for first two years and on re-designation by committee on in third year as SRF @ 35000/- p.m. vide OM no. 10/1(21)/2014/Fellowship/R&D-II/5739 dated 03/05/2019.

Please note that as per the government orders under Direct Benefit Transfer (DBT) scheme, the staff salary has to be transferred to his/her bank account. Accordingly, Aadhar Number(UID) of the appointed staff, Bank Account details and the Mobile number linked to the bank account should be obtained and it should be intimated to this office.

Overheads is calculated @ 7.5% of all other heads except contingency. The remaining 7.5% overheads i.e. (Rs. 1,06,388/-) shall be released only on meeting the requirements specified (See Annex-B).

- I am also pleased to convey the sanction of the President of India to incur an expenditure of Rs. 5,72,988/- (Rupees five lakh seventy two thousand nine hundred eighty eight only) towards grant for the year 2019-2020 .
- The expenditure involved is debit to: 04 3401 00 004 27 0231.
- This is issued with the concurrence of the competent authority in the Department.

Pay & Accounts Officer,  
DAE, Mumbai - 400 001.

*Ashok K. B.*  
22.7.2019  
Ashok K. B.  
Programme Officer, BRNS  
Board of Research in Nuclear Sciences,  
Department of Atomic Energy,  
BRNS Secretariat, 3rd Floor, CFB  
B.A.R.C., Trombay, Mumbai - 400085



# Vivekanand Education Society's Institute of Technology

(Affiliated to University of Mumbai, Approved by AICTE & Recognized by Govt. of Maharashtra)

Copy forwarded to:

1. Director of Audit, Scientific Department, AEAP, OYC, CSM Marg, Mumbai-400 001.
2. Joint Secretary (R&D), DAE, Anushakti Bhavan, CSM Marg, Mumbai-400 001.
3. Principal, V.E.S. Institute of Technology, MUMBAI, Maharashtra, 400074..
4. Principal Investigator(PI): Dr.(Mrs.) Jayalekshmi M Nair, Principal, V.E.S. Institute of Technology, MUMBAI, Maharashtra, 400074..

A. First year grant is being released in full along with this Sanction Letter through Pay & Accounts Officer, Department of Atomic Energy, Anushakti Bhavan, CSM Marg, Mumbai-400 001 directly. You may await a Money transfer (MT) through ECS and The amount would be credited electronically to A/C No: 0229101132845, A/C Name: V.E.S. Institute of Technology, IFSC: CNRB0000229, Sindhi Society Branch, Chembur, Mumbai-400071.

i) Acceptance of this sanction and the MT for the amount sanctioned for the first financial year may please be acknowledged (Form-I).

ii) A sticker of the BRNS LOGO (Copy Enclosed) should be pasted on all the items procured under the project.

iii) THIS SANCTION IS FURTHER SUBJECT TO THE CONDITIONS STIPULATED IN ANNEX (ENCLOSED), WHICH MAY BE GONE THROUGH CAREFULLY.

B. Second year Sanction Letter will be issued automatically in the month of April/May of the 2nd financial year, however, the grant will be released (unspent balance of previous year and Interest earned will be adjusted) after the PI submits the following documents to the Programme Officer NPP:

a) Claim in Form-II quoting the reference of the sanction issued for the first year.

b) Utilisation Certificate (UC) as on 31st March of the preceding financial year in Form-III duly audited by the Internal Auditor of the University/ Institution or a Chartered Accountant.

c) Statement of Accounts (SA) as on 31st March of the preceding financial year should be updated on the website. Interest earned in previous year should be reflected in the Statement of Accounts. A printout of the same should be sent to BRNS after it is duly audited by the Internal Auditor of the University/ Institution or a Chartered Accountant.

d) Copy of appointment order and joining report of the staff appointed for the project along with minutes of the Selection Committee, alongwith HRA CLAIM (if applicable), should be uploaded in a single pdf file under the file head "Staff Appointment Details". In addition, the details of the appointed staff should also be updated in the available menu.

e) The Inventory of equipment also should be updated in the menu, besides uploading the purchase order of the items costing more than 1 Lakh.

f) A One Page report on the progress of work during first year.

C. Third and subsequent years (if any) the Sanction Letter and the grant will be released on fulfillment of the following requirements:

i) Renewal/ Extension Application: Principal Investigator (PI) is required to upload by January 15 a pdf copy of duly signed renewal/ extension application in the prescribed form-(PRA) after logging into his/her account at <https://brns.res.in>. All applications received shall be examined by experts from the field and PIs may be invited to a Technical Programme Discussion Meeting (TPDM). Renewal of the project will be based on the recommendations of the TPDM, Advisory Committee and the Board.

ii) Sanction Letter: If the progress is found to be satisfactory the renewal sanction for the year will be issued in the beginning of that financial year in April/May.

iii) Claim: On receipt of the renewal sanction, the PI shall claim the funds sanctioned by submitting the following documents to Programme Officer NPP, BRNS Secretariat, First Floor, Central Complex, BARC, Trombay, Mumbai-400 085:

a) Claim in Form-II quoting reference of the renewal sanction.

b) Utilisation Certificate (UC) as on 31st March of the preceding financial year in Form-III duly audited by the Internal Auditor of the University/ Institution or a Chartered Accountant. should be reflected in the Statement of Accounts.

c) Statement of Accounts (SA) as on 31st March of the preceding financial year including the amount of Interest earned in previous year and duly audited by the Internal Auditor of the University/ Institution or a Chartered Accountant.

d) Copy of appointment order and joining report of the staff appointed for the project along with minutes of the Selection Committee.

Principal Investigator  
Dr. (Mrs.) Jayalekshmi M. Nair  
Principal, V.E.S. Institute of Technology





# Vivekanand Education Society's Institute of Technology

(Affiliated to University of Mumbai, Approved by AICTE & Recognized by Govt. of Maharashtra)

- e) An inventory of equipment and the copy of Purchase order of equipments costing more than 1 Lakh.
- D. At the end of Terminal Year the Settlement Grant and the Balance 7.5% Overheads will be released on fulfillment of the following requirements:
- Claim Form-II if any,
  - The final Consolidated Statement of Accounts (SA) and Consolidated Utilization Certificate duly audited by an external Chartered Accountant or the Statutory (Govt.) Auditor. It is mandatory to include the amount of bank interest earned on the grant released into the SA.
  - Final Consolidated Progress Report and a brief report as per format given in Form-VII .
5. AAO (Cheque), DAE, Anushakti Bhavan, CSM Marg, Mumbai - 400 001 – With a request that the amount granted for the first year of the project may be released.
6. Member Secretary, CDP-1:NPP, BRNS: Shri Vinod V. SOIG, ETHD, FRTG, IGCAR, Kalpakkam – 603102
7. Co-Investigator (CI) : Mrs. Sangeetha Prasanna Ram, VESIT, Chembur, Mumbai, Email : sangeeta.prasannaram@ves.ac.in, Mobile :9819782500
8. Project Collaborator (PC): Dr. Gayatri Mohanto, NPD, BARC, Email : gayatrimohanto@gmail.com, Mobile :2225596173Dr. Bidyut Roy, BARC, Email : bjroy@barc.gov.in, Mobile :2225593457

You or your nominee may please be the DAE representative for selection of Research Fellow/ Research Associate for the project.

*Ashok K. Pandey*  
22-7-2019

Program Officer, BRNS

Note:

1. Please quote the Sanction Number 51/14/07/2019-BRNS in all your correspondence with BRNS
- Ashok K. Pandey  
Programme Officer  
Board of Research in Nuclear Sciences,  
Department of Atomic Energy,  
BRNS Secretariat, 3rd Floor, CFB  
B.A.R.C., Trombay, Mumbai - 400085



# Vivekanand Education Society's Institute of Technology

(Affiliated to University of Mumbai, Approved by AICTE & Recognized by Govt. of Maharashtra)

**BLANK PAGE**



# Vivekanand Education Society's Institute of Technology

Since 1962

(Affiliated to University of Mumbai, Approved by AICTE & Recognized by Govt. of Maharashtra)

8/27/2021

Welcome to Vivekanand Education Society Mail - Fwd: Team ID 1159573 , Cash Prize Details, IICDC Conclave 2019



N GopalKrishnan <n.gopalkrishnan@ves.ac.in>

**Fwd: Team ID 1159573 , Cash Prize Details, IICDC Conclave 2019**

2 messages

**Mrugendra Vasmatkar** <mrugendra.vasmatkar@ves.ac.in>  
To: N GopalKrishnan <n.gopalkrishnan@ves.ac.in>

Thu, Aug 26, 2021 at 2:23 PM

----- Forwarded message -----

From: **Mrugendra Vasmatkar** <mrugendra.vasmatkar@ves.ac.in>  
Date: Fri, Jul 16, 2021, 16:07  
Subject: Team ID 1159573 , Cash Prize Details, IICDC Conclave 2019  
To: Vikas Pange <vikas.pange@ves.ac.in>

Dear sir,

The Following is the mail received by IICDC for the prize. Certificates of the students are also attached. Mentor Certificate is still not received. Generally they send Memento for it.

Link for Photo :

Project Name : Multi-Functional Detachable Applications For Drones  
Tema Name : Dronevolution  
Mentor Name : Mrugendra M Vasmatkar  
Tema Members : Siddhant Satam ( team Lead)  
Sai rane, Abhishek Desale, Deepak Mishra, Sanket Bhagde, Pranjal Thorat

Description :

This project is not a drone but these are various applications which can be implemented on any land based or aerial drone which will make that drone capable of performing these applications. All the applications which will be developed will be focused towards various problems in our society which can be easily solved by implementing various types of drones for the applications. The planned applications to be implemented on drones are: Air Terrain Attachment, Pollution and weather monitoring and Mapping, LIDAR Based Mapping and Military Surveillance, Fire Fighting combined with Solar Panel Cleaning, Agricultural Watering with Pesticides Spraying, Secured Delivery Attachment

Regards,

Mrugendra Vasmatkar

----- Forwarded message -----

From: **SIDDHANT SATAM** <2017.siddhant.satam@ves.ac.in>  
Date: Tue, Jun 15, 2021 at 4:14 PM  
Subject: Fwd: Team ID 1159573 , Cash Prize Details, IICDC Conclave 2019  
To: Mrugendra Vasmatkar <mrugendra.vasmatkar@ves.ac.in>

----- Forwarded message -----

From: **ShalinWings H.O** <sho-ve1@wingsevents.com>  
Date: Wed, Jun 9, 2021 at 8:23 PM  
Subject: Team ID 1159573 , Cash Prize Details, IICDC Conclave 2019

<https://mail.google.com/mail/u/0/?ik=4cb2a7172b&view=pt&search=all&permthid=thread-F%3A1709145337602729930&asqt=1&siml=msg-F%3A1709145337602729930&siml=msg-F%3A17091494575...> 1/4



# Vivekanand Education Society's Institute of Technology

Since 1962

(Affiliated to University of Mumbai, Approved by AICTE & Recognized by Govt. of Maharashtra)

8/27/2021

Welcome to Vivekanand Education Society Mail - Fwd: Team ID 1159573 , Cash Prize Details, ICDC Conclave 2019

Sidhant Satam.pdf  
83K

**Mrugendra Vasmatkar** <mrugendra.vasmatkar@ves.ac.in>  
To: N. Gopalkrishnan <n.gopalkrishnan@ves.ac.in>

Thu, Aug 26, 2021 at 3:28 PM

----- Forwarded message -----

From: **SIDDHANT SATAM** <2017.sidhant.satam@ves.ac.in>  
Date: Tue, Jun 15, 2021, 16:14  
Subject: Fwd: Team ID 1159573 , Cash Prize Details, ICDC Conclave 2019  
To: Mrugendra Vasmatkar <mrugendra.vasmatkar@ves.ac.in>

----- Forwarded message -----

From: **ShaliniWings H.O** <sh-wings1@wingsevents.com>  
Date: Wed, Jun 9, 2021 at 6:23 PM  
Subject: Team ID 1159573 , Cash Prize Details, ICDC Conclave 2019  
To: <2017.sidhant.satam@ves.ac.in>  
Cc: <0295831@ts.com>, Akshy Kulkarni@Events/Wings H.O <akshy@wingsevents.com>

Greetings from Texas Instruments!

Congratulations for being among the Top 60 Winning team of ICDC Conclave , DST & Texas Instruments (TI) Inc. India Innovation Challenge Design Contest 2019, anchored by the Indian Institute of Management (IIM), Bangalore.

It gives us great pleasure to notify that the Prize money won by you and your team has been credited into the Team Leader's account as per the details mentioned below.

**Cash Prize Amount** : Rs -19477/-  
**Prize amount transacted** : Rs- 13400/-  
**UTR number** : 106075063194  
**TDS @ 31.2%** : Rs -6077/-

**PS : Action Required** : Kindly acknowledge the receive in the Google form Link < <https://forms.gle/wCcLGybMBPz3iega9> > by 10<sup>th</sup> June 2021.

Regards,

Wings Event Management Team

<https://mail.google.com/mail/u/07/k=4cb2a7172b&view=pt&search=all&permthid=thread-F63A1709145337602729930&asat=1&siml=msg-F63A1709145337602729930&siml=msg-F63A17091494575...> 3/4

8/27/2021

Welcome to Vivekanand Education Society Mail - Fwd: Team ID 1159573 , Cash Prize Details, ICDC Conclave 2019

To: <2017.sidhant.satam@ves.ac.in>  
Cc: <0295831@ts.com>, Akshy Kulkarni@Events/Wings H.O <akshy@wingsevents.com>

Greetings from Texas Instruments!

Congratulations for being among the Top 60 Winning team of ICDC Conclave , DST & Texas Instruments (TI) Inc. India Innovation Challenge Design Contest 2019, anchored by the Indian Institute of Management (IIM), Bangalore.

It gives us great pleasure to notify that the Prize money won by you and your team has been credited into the Team Leader's account as per the details mentioned below.

**Cash Prize Amount** : Rs -19477/-  
**Prize amount transacted** : Rs- 13400/-  
**UTR number** : 106075063194  
**TDS @ 31.2%** : Rs -6077/-

**PS : Action Required** : Kindly acknowledge the receive in the Google form Link < <https://forms.gle/wCcLGybMBPz3iega9> > by 10<sup>th</sup> June 2021.

Regards,

Wings Event Management Team

(On Behalf of Texas Instruments University Program)

5 attachments

**Abhishek Desale.pdf**  
83K

**DeepakMishra.pdf**  
83K

**SanketBhegde.pdf**  
83K

**Franjali Thorat.pdf**  
83K

**Sai Rane.pdf**  
83K





# Vivekanand Education Society's Institute of Technology

(Affiliated to University of Mumbai, Approved by AICTE & Recognized by Govt. of Maharashtra)

5/10/2021 Welcome to Vivekanand Education Society Mail - Fwd: You've received Azure academic credit as part of the Azure Sponsorship offer



Bincy Chellapandi <2018.bincy.chellapandi@ves.ac.in>

## Fwd: You've received Azure academic credit as part of the Azure Sponsorship offer

3 messages

**M Vijayalakshmi** <m.vijayalakshmi@ves.ac.in>  
To: 2018.bincy.chellapandi@ves.ac.in

Mon, Nov 25, 2019 at 2:54 PM

Regards,

Dr. (Mrs.) M. Vijayalakshmi  
Vice-Principal,  
Vivekanand Education Society's Institute Of Technology,  
Hashu Advani Memorial Complex, Collector Colony, Chembur East, Mumbai - 400074.

Contact : +91-9820882766 | 022-61532592

----- Forwarded message -----

From: **Microsoft Azure** <azure-noreply@microsoft.com>  
Date: Sat, Nov 9, 2019 at 1:30 AM  
Subject: You've received Azure academic credit as part of the Azure Sponsorship offer  
To: <m.vijayalakshmi@ves.ac.in>



## You have USD 10000 in Azure academic credit for your classroom

As part of the [Azure Sponsorship](#) offer, you've received Azure academic credit that's good toward Azure services for your classroom via the Azure Education Hub.

Account ID: [m.vijayalakshmi@ves.ac.in](mailto:m.vijayalakshmi@ves.ac.in)

Usage cap: USD 10000

Grant end date: November 1, 2020

To start using your credit, sign into the [Azure Education Hub](#), [set up and manage your classroom](#), invite students, and manage your credit.

[Access your credit >](#)

If you need assistance, please [create a support request](#).



# Vivekanand Education Society's Institute of Technology

Since 1962

(Affiliated to University of Mumbai, Approved by AICTE & Recognized by Govt. of Maharashtra)

1111

University of Mumbai



Research Project No: 1111

NAME OF THE RESEARCHER : Mrs. Nudyal Anand  
LECTURE IN : Electronics & Telecommunication  
AMOUNT SANCTIONED : Rs. 15000  
CO-INVESTIGATOR : R.S. Aswal

Ref No. AAMS/ICD/106 of 2021  
23<sup>rd</sup> July, 2021

To,

Vivekanand Education Societys Institute of  
Technology, Hashu Advani Memorial Complex,  
Collector's Colony, R.C. Marg, Chembur,  
Mumbai-400 074.

**VIVEKANAND EDUCATION SOCIETY'S  
INSTITUTE OF TECHNOLOGY**  
RECEIVED  
INWARD SECTION  
NO. 24  
17/09/2021

Sub - Minor Research Grant Project.

Sir/Madam,

I am directed to inform you that the said proposal has been considered by the University and the research grant as quoted above is sanctioned to the researcher.

The sanctioned amount will be disbursed in two installments. The first installment of 70% of the sanctioned amount will be disbursed within the month of August. The remaining 30% amount will be disbursed up to 31st December, 2021

The researcher is expected to spend 30% amount initially from his/her own resources to carry out the work.

Further, I am to inform you that the researcher will have to utilize the 100% sanctioned amount on or before 31st December, 2021 and submit original bills/vouchers of the expenditure alongwith Utilization Certificate duly certified by the Principal/ Director/ Head/Institute/University Department of the College to The Deputy Registrar, Accounts Section, Mahatma Phule Bhavan, Vidyanagari, Kalina Campus, University of Mumbai, Mumbai - 400 098 .

The report of the research work carried out by the concerned researcher will have to be submitted to the University on or before 31st December, 2021.

The Principal/Head of the Institute are requested to inform the researcher accordingly and arrange to forward his/her undertaking immediately to enable this office to release first installment of the research grant.

Yours faithfully,

  
Assistant Registrar  
(Academic Planning & Development Section)



# Vivekanand Education Society's Institute of Technology

(Affiliated to University of Mumbai, Approved by AICTE & Recognized by Govt. of Maharashtra)

**BLANK PAGE**





# Vivekanand Education Society's Institute of Technology

Since 1962

(Affiliated to University of Mumbai, Approved by AICTE & Recognized by Govt. of Maharashtra)

University of Mumbai



Research Project No: 1124

NAME OF THE RESEARCHER : Mrs. Jyoti Dawkhay  
LECTURE IN : Electronics & Telecommunication  
AMOUNT SANCTIONED : Rs. 25000/-  
CO-INVESTIGATOR :

RefNo. AAMS/ICD/106 of 2021

23<sup>rd</sup> July, 2021

To,

Vivekanand Education Societys Institute of  
Technology, Hashu Advani Memorial Complex,  
Collector's Colony, R.C. Marg, Chembur,  
Mumbai-400 074.

Sub - Minor Research Grant Project.

Sir/Madam,

I am directed to inform you that the said proposal has been considered by the University and the research grant as quoted above is sanctioned to the researcher.

The sanctioned amount will be disbursed in two installments. The first installment of 70% of the sanctioned amount will be disbursed within the month of August. The remaining 30% amount will be disbursed up to 31st December, 2021.

The researcher is expected to spend 30% amount initially from his/her own resources to carry out the work.

Further, I am to inform you that the researcher will have to utilize the 100% sanctioned amount on or before 31st December, 2021 and submit original bills/vouchers of the expenditure alongwith Utilization Certificate duly certified by the Principal/ Director/ Head/Institute/University Department of the College to The Deputy Registrar, Accounts Section, Mahatma Phule Bhavan, Vidyanagari, Kalina Campus, University of Mumbai, Mumbai - 400 098.

The report of the research work carried out by the concerned researcher will have to be submitted to the University on or before 31st December, 2021.

The Principal/Head of the Institute are requested to inform the researcher accordingly and arrange to forward his/her undertaking immediately to enable this office to release first installment of the research grant.

Yours faithfully,

Assistant Registrar  
(Academic Planning & Development Section)



# Vivekanand Education Society's Institute of Technology

(Affiliated to University of Mumbai, Approved by AICTE & Recognized by Govt. of Maharashtra)

University of Mumbai

Research Project No: 502

NAME OF THE RESEARCHER: Dr. Saylee M. Ghonge  
LECTURE IN Electronic & Tele Communication  
AMOUNT SANCTIONED: Rs. 25000/-

Ref No. APD/237/429 of 2017  
16<sup>th</sup> January, 2017

To,  
The Principal,  
Vivekanand Edu. Soc's Inst. of Technology,  
Collector Colony,  
Chembur,  
Mumbai - 400 074.

Sir/Madam,

With reference to the Research Proposal forwarded by you in respect of Shri/Smt/Kum Dr. Saylee M. Ghonge, I am directed to inform you that the said proposal has been considered by the University and the Committee has recommended research grant as quoted above to the researcher.

The sanctioned amount will be disbursed in two instalments. The first instalment of 50% of the sanctioned amount will be disbursed within 15 days on receiving undertaking and RTGS Form (copy enclosed) from the researcher.

The researcher is expected to spend 50% amount initially from his/her own resources to carry out the work. **Please note that 50% balance amount, out of sanctioned grant will be released on the submission of utilization certificate including bills/vouchers/receipts in original on or before 31<sup>st</sup> March, 2017 failing of which the advance amount granted will be recovered from researcher which please note.**

Further, I am to inform you that the researcher will have to utilize the sanctioned amount before 31<sup>st</sup> March, 2017 and submit original bills/vouchers of the expenditure along with Utilization Certificate (copy enclosed) duly certified by the Principal /Director /Head /Institute /University Department/College, to the A.P.D. Section, after verification through the Accounts Section, Gr. Floor, Room No. 13, Fort, Mumbai - 400 032.

The report of the research work carried out by the concerned researcher will have to be submitted to the University on or before 31<sup>st</sup> July, 2017.

The Principal/Head of the Institute are requested to inform the researcher accordingly and arrange to forward his/her undertaking along with RTGS Form immediately to enable this office to release first instalment of the research grant, accordingly.

Yours faithfully,

  
For REGISTRAR



# Vivekanand Education Society's Institute of Technology

(Affiliated to University of Mumbai, Approved by AICTE & Recognized by Govt. of Maharashtra)

University of Mumbai



Research Project No: 975

NAME OF THE RESEARCHER : Prof. Sharmila Sengupta  
LECTURE IN : Computer Engg  
AMOUNT SANCTIONED : 30,000/-  
CO-INVESTIGATOR : \_\_\_\_\_

Ref No. AAMS/ICD/106 of 2021  
23<sup>rd</sup> July, 2021

To,

Vivekanand Education Societys Institute of  
Technology, Hashu Advani Memorial Complex,  
VES Campus II, Chembur - 400 074

RECEIVED  
INWARD SECTION  
No. 26  
17/9/21

Sub: - Minor Research Grant Project,

Sir/Madam,

I am directed to inform you that the said proposal has been considered by the University and the research grant as quoted above is sanctioned to the researcher.

The sanctioned amount will be disbursed in two installments. The first installment of 70% of the sanctioned amount will be disbursed within the month of August. The remaining 30% amount will be disbursed up to 31st December, 2021.

The researcher is expected to spend 30% amount initially from his/her own resources to carry out the work.

Further, I am to inform you that the researcher will have to utilize the 100% sanctioned amount on or before 31st December, 2021 and submit original bills/vouchers of the expenditure alongwith Utilization Certificate duly certified by the Principal/ Director/ Head/Institute/University Department of the College to The Deputy Registrar Accounts Section, Mahatma Phule Bhavan, Vidyanagari, Kalina Campus, University of Mumbai, Mumbai - 400 098 .

The report of the research work carried out by the concerned researcher will have to be submitted to the University on or before 31st December, 2021.

The Principal/Head of the Institute are requested to inform the researcher accordingly and arrange to forward his/her undertaking immediately to enable this office to release first installment of the research grant.

Yours faithfully,  
  
Assistant Registrar  
(Academic Planning & Development Section)



# Vivekanand Education Society's Institute of Technology

(Affiliated to University of Mumbai, Approved by AICTE & Recognized by Govt. of Maharashtra)

University of Mumbai

960



Research Project No : 460

NAME OF THE RESEARCHER : Lifna C. S.  
LECTURE IN : Computer Engg.  
AMOUNT SANCTIONED : 15,000/-  
CO-INVESTIGATOR :

Ref No. AAMS/ICD/106 of 2021  
23<sup>rd</sup> July, 2021

To,

Vivekanand Education Societys Institute of  
Technology, Hashu Advani Memorial Complex,  
VES Campus II, Chembur - 400 074

Sub: - Minor Research Grant Project.

Sir/Madam,

I am directed to inform you that the said proposal has been considered by the University and the research grant as quoted above is sanctioned to the researcher.

The sanctioned amount will be disbursed in two installments. The first installment of 70% of the sanctioned amount will be disbursed within the month of August. The remaining 30% amount will be disbursed up to 31st December, 2021.

The researcher is expected to spend 30% amount initially from his/her own resources to carry out the work.

Further, I am to inform you that the researcher will have to utilize the 100% sanctioned amount on or before 31st December, 2021 and submit original bills/vouchers of the expenditure alongwith Utilization Certificate duly certified by the Principal/ Director/ Head/Institute/University Department of the College to The Deputy Registrar Accounts Section, Mahatma Phule Bhavan, Vidyanagari, Kalina Campus, University of Mumbai, Mumbai - 400 098.

The report of the research work carried out by the co-concerned researcher will have to be submitted to the University on or before 31st December, 2021.

The Principal/Head of the Institute are requested to inform the researcher accordingly and arrange to forward his/her undertaking immediately to enable this office to release first installment of the research grant.

Yours faithfully,

  
Assistant Registrar  
(Academic Planning & Development Section)





# Vivekanand Education Society's Institute of Technology

(Affiliated to University of Mumbai, Approved by AICTE & Recognized by Govt. of Maharashtra)

University of Mumbai



Research Project No : 925

NAME OF THE RESEARCHER : Mrs. Abha Tewari  
LECTURE IN : Computer Engg  
AMOUNT SANCTIONED : 25,000/-  
CO-INVESTIGATOR :

Ref No. AAMS/ICD/106 of 2021  
23<sup>rd</sup> July, 2021

To,

Vivekanand Education Societys Institute of  
Technology, Hshu Advani Memorial Complex,  
VES Campus II, Chembur - 400 074.



Sub: - Minor Research Grant Project.

Sir/Madam,

I am directed to inform you that the said proposal has been considered by the University and the research grant as quoted above is sanctioned to the researcher.

The sanctioned amount will be disbursed in two installments. The first installment of 70% of the sanctioned amount will be disbursed within the month of August. The remaining 30% amount will be disbursed up to 31st December, 2021.

The researcher is expected to spend 30% amount initially from his/her own resources to carry out the work.

Further, I am to inform you that the researcher will have to utilize the 100% sanctioned amount on or before 31st December, 2021 and submit original bills/vouchers of the expenditure alongwith Utilization Certificate duly certified by the Principal/ Director/ Head/Institute/University Department of the College to The Deputy Registrar Accounts Section, Mahatma Phule Bhavan, Vidyanagari, Kalina Campus, University of Mumbai, Mumbai - 400 098.

The report of the research work carried out by the concerned researcher will have to be submitted to the University on or before 31st December, 2021.

The Principal/Head of the Institute are requested to inform the researcher accordingly and arrange to forward his/her undertaking immediately to enable this office to release first installment of the research grant.

Yours faithfully,

  
Assistant Registrar  
(Academic Planning & Development Section)



# Vivekanand Education Society's Institute of Technology

(Affiliated to University of Mumbai, Approved by AICTE & Recognized by Govt. of Maharashtra)

University of Mumbai



Research Project No : 923

NAME OF THE RESEARCHER : MS. Kajal Jewani  
LECTURE IN : Computer Engg.  
AMOUNT SANCTIONED : 15,000/-  
CO-INVESTIGATOR :  
:

Ref No. AAMS/ICD/106 of 2021

23<sup>rd</sup> July, 2021

To,

Vivekanand Education Societys Institute of  
Technology,  
Collectors Colony . Chembur, Mumbai - 400 074

Sub - Minor Research Grant Project.

Sir/Madam,

I am directed to inform you that the said proposal has been considered by the University and the research grant as quoted above is sanctioned to the researcher.

The sanctioned amount will be disbursed in two instalments. The first instalment of 70% of the sanctioned amount will be disbursed within the month of August. The remaining 30% amount will be disbursed up to 31st December, 2021.

The researcher is expected to spend 30% amount initially from his/her own resources to carry out the work.

Further, I am to inform you that the researcher will have to utilize the 100% sanctioned amount on or before 31st December, 2021 and submit original bills/vouchers of the expenditure alongwith Utilization Certificate duly certified by the Principal/ Director/ Head/Institute/University Department of the College to The Deputy Registrar, Accounts Section, Mahatma Phule Bhavan, Vidyanagari, Kalina Campus, University of Mumbai, Mumbai - 400 098.

The report of the research work carried out by the concerned researcher will have to be submitted to the University on or before 31st December, 2021.

The Principal/Head of the Institute are requested to inform the researcher accordingly and arrange to forward his/her undertaking immediately to enable this office to release first installment of the research grant.

Yours faithfully,

Assistant Registrar  
(Academic Planning & Development Section)



# Vivekanand Education Society's Institute of Technology

Since 1962

(Affiliated to University of Mumbai, Approved by AICTE & Recognized by Govt. of Maharashtra)

947

University of Mumbai



Research Project No : 947

NAME OF THE RESEARCHER : Mrs. Vidya Sachin Zope  
LECTURE IN : Computer Engg  
AMOUNT SANCTIONED : 10,000/-  
CO-INVESTIGATOR :

Ref No. AAMS/ICD/106 of 2021  
22<sup>nd</sup> July, 2021

To,

Vivekanand Education Societys Institute of  
Technology, Hashu Advani Memorial Complex,  
Collector's Colony, R.C. Marg, Chembur,  
Mumbai-400 074.

Sub: - Minor Research Grant Project.

Sir/Madam,

I am directed to inform you that the said proposal has been considered by the University and the research grant as quoted above is sanctioned to the researcher.

The sanctioned amount will be disbursed in two instalments. The first installment of 70% of the sanctioned amount will be disbursed within the month of August. The remaining 30% amount will be disbursed up to 31st December, 2021.

The researcher is expected to spend 30% amount initially from his/her own resources to carry out the work.

Further, I am to inform you that the researcher will have to utilize the 100% sanctioned amount on or before 31st December, 2021 and submit original bills/vouchers of the expenditure alongwith Utilization Certificate duly certified by the Principal/ Director/ Head/Institute/University Department of the College to The Deputy Registrar, Accounts Section, Mahatma Phule Bhavan, Vidyanagari, Kalina Campus, University of Mumbai, Mumbai - 400 098.

The report of the research work carried out by the concerned researcher will have to be submitted to the University on or before 31st December, 2021.

The Principal/Head of the Institute are requested to inform the researcher accordingly and arrange to forward his/her undertaking immediately to enable this office to release first installment of the research grant.

Yours faithfully,

Assistant Registrar  
(Academic Planning & Development Section)



# Vivekanand Education Society's Institute of Technology

Since 1962

(Affiliated to University of Mumbai, Approved by AICTE & Recognized by Govt. of Maharashtra)

University of Mumbai

633



Research Project No : 633

NAME OF THE RESEARCHER : Dr. Maya Bhat  
LECTURE IN : Chemistry  
AMOUNT SANCTIONED : 60,000/-  
CO-INVESTIGATOR :

Ref No. AAMS/ICD/106 of 2021

23<sup>rd</sup> July, 2021

To,

Vivekanand Education Societys Institute of  
Technology, Hashu Advani Memorial Complex,  
Collector's Colony, R.C. Marg, Chembur,  
Mumbai-400 074.

Sub: - Minor Research Grant Project.

Sir/Madam,

I am directed to inform you that the said proposal has been considered by the University and the research grant as quoted above is sanctioned to the researcher.

The sanctioned amount will be disbursed in two installments. The first installment of 70% of the sanctioned amount will be disbursed within the month of August. The remaining 30% amount will be disbursed up to 31st December, 2021.

The researcher is expected to spend 30% amount initially from his/her own resources to carry out the work.

Further, I am to inform you that the researcher will have to utilize the 100% sanctioned amount on or before 31st December, 2021 and submit original bills/vouchers of the expenditure alongwith Utilization Certificate duly certified by the Principal/ Director/ Head/Institute/University Department of the College to The Deputy Registrar, Accounts Section, Mahatma Phule Bhavan, Vidyanagari, Kalina Campus, University of Mumbai, Mumbai - 400 098.

The report of the research work carried out by the concerned researcher will have to be submitted to the University on or before 31st December, 2021.

The Principal/Head of the Institute are requested to inform the researcher accordingly and arrange to forward his/her undertaking immediately to enable this office to release first installment of the research grant.

Yours faithfully,

Assistant Registrar  
(Academic Planning & Development Section)





# Vivekanand Education Society's Institute of Technology

Since 1962

(Affiliated to University of Mumbai, Approved by AICTE & Recognized by Govt. of Maharashtra)

University of Mumbai



Research Project No : 903

NAME OF THE RESEARCHER : Namrata V. Bonde  
LECTURE IN : Electrical Engg.  
AMOUNT SANCTIONED : 25,000/-  
CO-INVESTIGATOR :

Ref No. AAMS/ICD/106 of 2021  
23<sup>rd</sup> July, 2021

To,

Vivekanand Education Societys Institute of  
Technology,  
Collectors Colony , Chembur, Mumbai - 400 074

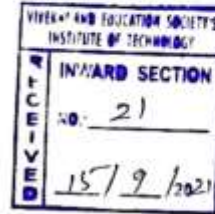

Sub: - Minor Research Grant Project.

Sir/Madam,

I am directed to inform you that the said proposal has been considered by the University and the research grant as quoted above is sanctioned to the researcher.

The sanctioned amount will be disbursed in two installments. The first installment of 70% of the sanctioned amount will be disbursed within the month of August. The remaining 30% amount will be disbursed up to 31st December, 2021.

The researcher is expected to spend 30% amount initially from his/her own resources to carry out the work.

Further, I am to inform you that the researcher will have to utilize the 100% sanctioned amount on or before 31st December, 2021 and submit original bills/vouchers of the expenditure alongwith Utilization Certificate duly certified by the Principal/ Director/ Head/Institute/University Department of the College to The Deputy Registrar, Accounts Section, Mahatma Phule Bhavan, Vidyanagari, Kalina Campus, University of Mumbai, Mumbai - 400 098 .

The report of the research work carried out by the concerned researcher will have to be submitted to the University on or before 31st December, 2021.

The Principal/Head of the Institute are requested to inform the researcher accordingly and arrange to forward his/her undertaking immediately to enable this office to release first installment of the research grant.

Yours faithfully,

  
Assistant Registrar  
(Academic Planning & Development Section)

Scanned with CamScanner



Since 1962

# Vivekanand Education Society's Institute of Technology

(Affiliated to University of Mumbai, Approved by AICTE & Recognized by Govt. of Maharashtra)

University of Mumbai



Research Project No : 902

NAME OF THE RESEARCHER : Mrs. Deepthi Khimani  
LECTURE IN : Electrical Engineering  
AMOUNT SANCTIONED : 25,000/-  
CO-INVESTIGATOR :

Ref No. AAMS/ICD/106 of 2021  
23<sup>rd</sup> July, 2021

To,

Vivekanand Education Societys Institute of  
Technology, Hashu Advani Memorial Complex,  
Collector's Colony, R.C. Marg, Chembur,  
Mumbai-400 074.

Sub - Minor Research Grant Project.

Sir/Madam,

I am directed to inform you that the said proposal has been considered by the University and the research grant as quoted above is sanctioned to the researcher.

The sanctioned amount will be disbursed in two installments. The first installment of 70% of the sanctioned amount will be disbursed within the month of August. The remaining 30% amount will be disbursed up to 31st December, 2021.

The researcher is expected to spend 30% amount initially from his/her own resources to carry out the work.

Further, I am to inform you that the researcher will have to utilize the 100% sanctioned amount on or before 31st December, 2021 and submit original bills/vouchers of the expenditure alongwith Utilization Certificate duly certified by the Principal/ Director/ Head/Institute/University Department of the College to The Deputy Registrar, Accounts Section, Mahatma Phule Bhavan, Vidyanagari, Kalina Campus, University of Mumbai, Mumbai - 400 098.

The report of the research work carried out by the concerned researcher will have to be submitted to the University on or before 31st December, 2021.

The Principal/Head of the Institute are requested to inform the researcher accordingly and arrange to forward his/her undertaking immediately to enable this office to release first installment of the research grant.

Yours faithfully,



Assistant Registrar  
(Academic Planning & Development Section)



# Vivekanand Education Society's Institute of Technology

Since 1962

(Affiliated to University of Mumbai, Approved by AICTE & Recognized by Govt. of Maharashtra)

University of Mumbai



Research Project No : 1084

NAME OF THE RESEARCHER : Anushree Prabhu  
LECTURE IN : Electronics Engg  
AMOUNT SANCTIONED : Rs. 20000/-  
CO-INVESTIGATOR :

Ref No. AAMS/ICD/106 of 2021

23<sup>rd</sup> July, 2021

To,

Vivekanand Education Societys Institute of  
Technology, Hashu Advani Memorial Complex,  
Collector's Colony, R.C. Marg, Chembur,  
Mumbai-400 074.

Sub: - Minor Research Grant Project.

Sir/Madam,

I am directed to inform you that the said proposal has been considered by the University and the research grant as quoted above is sanctioned to the researcher.

The sanctioned amount will be disbursed in two installments. The first installment of 70% of the sanctioned amount will be disbursed within the month of August. The remaining 30% amount will be disbursed up to 31st December, 2021.

The researcher is expected to spend 30% amount initially from his/her own resources to carry out the work.

Further, I am to inform you that the researcher will have to utilize the 100% sanctioned amount on or before 31st December, 2021 and submit original bills/vouchers of the expenditure alongwith Utilization Certificate duly certified by the Principal/ Director/ Head/Institute/University Department of the College to The Deputy Registrar, Accounts Section, Mahatma Phule Bhavan, Vidyanagari, Kalina Campus, University of Mumbai, Mumbai - 400 098.

The report of the research work carried out by the concerned researcher will have to be submitted to the University on or before 31st December, 2021.

The Principal/Head of the Institute are requested to inform the researcher accordingly and arrange to forward his/her undertaking immediately to enable this office to release first installment of the research grant.

Yours faithfully,

  
Assistant Registrar  
(Academic Planning & Development Section)



# Vivekanand Education Society's Institute of Technology

Since 1962

(Affiliated to University of Mumbai, Approved by AICTE & Recognized by Govt. of Maharashtra)

University of Mumbai



Research Project No : 1051

NAME OF THE RESEARCHER : Ms. Jayshree Hagde  
LECTURE IN : Information Technology  
AMOUNT SANCTIONED : RS - 15000/-  
CO-INVESTIGATOR : \_\_\_\_\_

RefNo. AAMS/CD/106 of 2021  
23<sup>rd</sup> July, 2021

To,

Vivekanand Education Societys Institute of  
Technology, Hashu Advani Memorial Complex,  
Collector's Colony, R.C. Marg, Chembur,  
Mumbai-400 074.

Sub: - Minor Research Grant Project.

Sir/Madam,

I am directed to inform you that the said proposal has been considered by the University and the research grant as quoted above is sanctioned to the researcher.

The sanctioned amount will be disbursed in two installments. The first installment of 70% of the sanctioned amount will be disbursed within the month of August. The remaining 30% amount will be disbursed up to 31st December, 2021.

The researcher is expected to spend 30% amount initially from his/her own resources to carry out the work.

Further, I am to inform you that the researcher will have to utilize the 100% sanctioned amount on or before 31st December, 2021 and submit original bills/vouchers of the expenditure alongwith Utilization Certificate duly certified by the Principal/ Director/ Head/Institute/University Department of the College to The Deputy Registrar, Accounts Section, Mahatma Phule Bhavan, Vidyanagari, Kalina Campus, University of Mumbai, Mumbai - 400 098.

The report of the research work carried out by the concerned researcher will have to be submitted to the University on or before 31st December, 2021.

The Principal/Head of the Institute are requested to inform the researcher accordingly and arrange to forward his/her undertaking immediately to enable this office to release first installment of the research grant.

Yours faithfully,

Assistant Registrar  
(Academic Planning & Development Section)





# Vivekanand Education Society's Institute of Technology

(Affiliated to University of Mumbai, Approved by AICTE & Recognized by Govt. of Maharashtra)

University of Mumbai



Research Project No : 1162

NAME OF THE RESEARCHER : Dr. Ramesh Solanki  
LECTURE IN : Computer Application  
AMOUNT SANCTIONED : RS. 15000/-  
CO-INVESTIGATOR :

Ref No. AAMS/ICD/106 of 2021  
23<sup>rd</sup> July, 2021

To,

Vivekanand Education Societys Institute of  
Technology, Collector Colony, HAMC, R. C.  
Marg, Chembur, Mumbai - 400 074.

Sub - Minor Research Grant Project.

Sir/Madam,

I am directed to inform you that the said proposal has been considered by the University and the research grant as quoted above is sanctioned to the researcher.

The sanctioned amount will be disbursed in two installments. The first installment of 70% of the sanctioned amount will be disbursed within the month of August. The remaining 30% amount will be disbursed up to 31st December, 2021.

The researcher is expected to spend 30% amount initially from his/her own resources to carry out the work.

Further, I am to inform you that the researcher will have to utilize the 100% sanctioned amount on or before 31st December, 2021 and submit original bills/vouchers of the expenditure alongwith Utilization Certificate duly certified by the Principal/ Director/ Head/Institute/University Department of the College to The Deputy Registrar, Accounts Section, Mahatma Phule Bhavan, Vidyanagari, Kalina Campus, University of Mumbai, Mumbai - 400 098.

The report of the research work carried out by the concerned researcher will have to be submitted to the University on or before 31st December, 2021.

The Principal/Head of the Institute are requested to inform the researcher accordingly and arrange to forward his/her undertaking immediately to enable this office to release first installment of the research grant.

Yours faithfully,

  
Assistant Registrar  
(Academic Planning & Development Section)



# Vivekanand Education Society's Institute of Technology

Since 1962

(Affiliated to University of Mumbai, Approved by AICTE & Recognized by Govt. of Maharashtra)

1049

University of Mumbai



Research Project No : 1049

NAME OF THE RESEARCHER : Ms. Asha Barambe  
LECTURE IN : Information Technology  
AMOUNT SANCTIONED : RS - 30000/-  
CO-INVESTIGATOR : \_\_\_\_\_

Ref No. AAMS/ICD/106 of 2021  
23<sup>rd</sup> July, 2021

To,

Vivekanand Education Society's Institute of  
Technology, Hashu Advani Memorial Complex,  
VES Campus II, Chembur - 400 074.

RECEIVED  
INVESTIG SECTION  
No. 27  
17/09/2021

**Sub: - Minor Research Grant Project.**

Sir/Madam,

I am directed to inform you that the said proposal has been considered by the University and the research grant as quoted above is sanctioned to the researcher.

The sanctioned amount will be disbursed in two installments. The first installment of 70% of the sanctioned amount will be disbursed within the month of August. The remaining 30% amount will be disbursed up to 31st December, 2021.

The researcher is expected to spend 30% amount initially from his/her own resources to carry out the work.

Further, I am to inform you that the researcher will have to utilize the 100% sanctioned amount on or before 31st December, 2021 and submit original bills/vouchers of the expenditure alongwith Utilization Certificate duly certified by the Principal/ Director/ Head/Institute/University Department of the College to The Deputy Registrar, Accounts Section, Mahatma Phule Bhavan, Vidyanagari, Kalina Campus, University of Mumbai, Mumbai - 400 098.

The report of the research work carried out by the concerned researcher will have to be submitted to the University on or before 31st December, 2021.

The Principal/Head of the Institute are requested to inform the researcher accordingly and arrange to forward his/her undertaking immediately to enable this office to release first installment of the research grant.

Yours faithfully,  
  
Assistant Registrar  
(Academic Planning & Development Section)



# Vivekanand Education Society's Institute of Technology

Since 1962

(Affiliated to University of Mumbai, Approved by AICTE & Recognized by Govt. of Maharashtra)

University of Mumbai



Research Project No : 1033

NAME OF THE RESEARCHER : Chayushela Nehete  
LECTURE IN : Information Technology  
AMOUNT SANCTIONED : RS - 15000/-  
CO-INVESTIGATOR :

Ref No. AAMS/ICD/106 of 2021  
23<sup>rd</sup> July, 2021

To,

Vivekanand Education Societys Institute of  
Technology, Hashu Advani Memorial Complex,  
Collector's Colony, R.C. Marg, Chembur,  
Mumbai-400 074.



Sub: - Minor Research Grant Project.

Sir/Madam,

I am directed to inform you that the said proposal has been considered by the University and the research grant as quoted above is sanctioned to the researcher.

The sanctioned amount will be disbursed in two installments. The first installment of 70% of the sanctioned amount will be disbursed within the month of August. The remaining 30% amount will be disbursed up to 31st December, 2021.

The researcher is expected to spend 30% amount initially from his/her own resources to carry out the work.

Further, I am to inform you that the researcher will have to utilize the 100% sanctioned amount on or before 31st December, 2021 and submit original bills/vouchers of the expenditure alongwith Utilization Certificate duly certified by the Principal/ Director/ Head/Institute/University Department of the College to The Deputy Registrar, Accounts Section, Mahatma Phule Bhavan, Vidyanageri, Kalina Campus, University of Mumbai, Mumbai - 400 098 .

The report of the research work carried out by the concerned researcher will have to be submitted to the University on or before 31st December, 2021.

The Principal/Head of the Institute are requested to inform the researcher accordingly and arrange to forward his/her undertaking immediately to enable this office to release first installment of the research grant.

Yours faithfully,

Assistant Registrar  
(Academic Planning & Development Section)

## University of Mumbai



Academic Planning and  
Development Section  
No. APD/ICD/2019-20/762  
17<sup>th</sup> March, 2020

Sub : Minor Research Grant Project 2019-20

Sir/Madam,

I am directed to inform you that the said proposal has been considered by the University and the research grant as quoted above is sanctioned to the researcher.

The sanctioned amount will be disbursed in two installments. The first installment of 40% of the sanctioned amount will be disbursed within the month of March. The remaining 60% amount will be disbursed up to 31<sup>st</sup> December, 2020.

The researcher is expected to spend 60% amount initially from his/her own resources to carry out the work.

Further, I am to inform you that the researcher will have to utilize the 40% sanctioned amount on or before 31<sup>st</sup> March, 2020 and submit original bills/vouchers of the expenditure along with Utilization Certificate duly certified by the Principal/Director/Head/Institute/University Department/College to the Accounts Section of the University.

Please note that 60% balance amount, out of sanctioned grant will be released after Poster Presentation & final approval of the committee. Therefore you need to submit of utilization certificate after presentation of your research including bills/vouchers/receipts in original through University Account Section.

The report of the research work carried out by the concerned researcher will have to be submitted to the University on or before 31<sup>st</sup> December, 2020.

The Principal/Head of the Institute are requested to inform the researcher accordingly and arrange to forward his/her undertaking immediately to enable this office to release first installment of the research grant.

Yours faithfully,



Deepak V. More  
Assistant Registrar  
(APD Section)





# Vivekanand Education Society's Institute of Technology

Since 1962

(Affiliated to University of Mumbai, Approved by AICTE & Recognized by Govt. of Maharashtra)

University of Mumbai



Research Project No : 891

NAME OF THE RESEARCHER : Mrs. Mugdha Ruturaj Jogalekar  
LECTURE IN : Electrical Engineering  
AMOUNT SANCTIONED : Rs. 35,000/-  
CO-INVESTIGATOR :

Ref No. AAMS/ICI/106 of 2021  
23<sup>rd</sup> July, 2021

To,

Vivekanand Institute of Technology,  
Collectors Colony, Chembur, Mumbai  
- 400 074.

Sub: - Minor Research Grant Project.

Sir/Madam,

I am directed to inform you that the said proposal has been considered by the University and the research grant as quoted above is sanctioned to the researcher.

The sanctioned amount will be disbursed in two installments. The first installment of 70% of the sanctioned amount will be disbursed within the month of August. The remaining 30% amount will be disbursed up to 31st December, 2021.

The researcher is expected to spend 30% amount initially from his/her own resources to carry out the work.

Further, I am to inform you that the researcher will have to utilize the 100% sanctioned amount on or before 31st December, 2021 and submit original bills/vouchers of the expenditure alongwith Utilization Certificate duly certified by the Principal/ Director/ Head/Institute/University Department of the College to The Deputy Registrar, Accounts Section, Mahatma Phule Bhavan, Vidyanagari, Kalina Campus, University of Mumbai, Mumbai - 400 098.

The report of the research work carried out by the concerned researcher will have to be submitted to the University on or before 31st December, 2021.

The Principal/Head of the Institute are requested to inform the researcher accordingly and arrange to forward his/her undertaking immediately to enable this office to release first installment of the research grant.

Yours faithfully,

Assistant Registrar  
(Academic Planning & Development Section)



SHOT ON REDMI NOTE5 PRO  
MI DUAL CAMERA





# Vivekanand Education Society's Institute of Technology

(Affiliated to University of Mumbai, Approved by AICTE & Recognized by Govt. of Maharashtra)

917	Neha Jain	Shree L. R. Tiwari College of Engineering	15000
918	Ms. Arti K. Gore	Saraswati Education Society's Saraswati College of Engineering	25000
919	Dr A K Sampath	Rizvi College of Engineering Rizvi Educational Complex Off Carter Road Sherly Rajan Village Bandra (West) Mumbai- 400 050.	15000
920	Prachi K Shahane	South Indian Education Society's Graduate School of Technology	25000
921	Sujata Bhaimallykar	Saraswati Education Society's Saraswati College of Engineering	15000
922	Dr.Prof. Rajesh Kadu	South Indian Education Society's Graduate School of Technology	25000
923	Ms. Kajal Jewani	Vivekanand Education Societys Institute of Technology	15000
924	Dr. Amit Barve	\Ramrao Adik Institute of Technology Sector-7 Dr. D. Y. Patil Vidyanagar Phase-I Nerul Navi Mumbai - 400 706\r\n\r\n"	15000
925	Mrs. Abha Tewari	Vivekanand Education Societys Institute of Technology	25000
926	Dr. Sangita Santosh Chaudhari	\Ramrao Adik Institute of Technology Sector-7 Dr. D. Y. Patil Vidyanagar Phase-I Nerul Navi Mumbai - 400 706\r\n\r\n"	30000
927	Dr. Vaibhav Eknath Narawade	\Ramrao Adik Institute of Technology Sector-7 Dr. D. Y. Patil Vidyanagar Phase-I Nerul Navi Mumbai - 400 706\r\n\r\n"	30000
928	Ms. Swati Ringe	Fr. Conceicao Rodrigues College of Engineering	30000
929	Ms. Rakhi Dattatraya Akhare	Lokmanya Tilak Jankalayn Shikshan Sanstha's Lokmanya Tilak College of Engineering Sector No.4 Vikas Nagar Kopar Khairane Navi Mumbai-400709	25000
930	Mr. Bahwant Jaywant Gorad	\Ramrao Adik Institute of Technology Sector-7 Dr. D. Y. Patil Vidyanagar Phase-I Nerul Navi Mumbai - 400 706\r\n\r\n"	25000
931	Dr. Rekha Ramesh	Mahavir Education Trust's - Shah and Anchor Kutchhi Engineering College	20000
932	Uday Bhawe	Mahavir Education Trust's - Shah and Anchor Kutchhi Engineering College	35000
933	Neelam Phadnis	Shree L. R. Tiwari College of Engineering	10000
934	Ms. Neha Nilesh Rane	\Mahatma Education Society\r\nPillai HOC College of Engg. & Technology Educational Campus HOC Colony Rasayani Tal.Khalapur \r\n\r\nDist. Raigad. - 410 207\r\n\r\n"	25000
935	Amol A.Dhumal	Mahavir Education Trust's - Shah and Anchor Kutchhi Engineering College	15000
936	Mr. Mahendra Patil	Atharva Educational Trust's College of Engineering	25000
937	Silviya Dmonte	Vidya Vikas Education Trust Universal College of Engineering	10000
938	Ms. Kavita R. Shelke	Agnel Charitable Trust's Fr. Conceicao Rodrigues Institute of Technology	40000
939	Dr. Satish Y. Ket	Manjara Charitable Trust's Rajiv Gandhi Institute of Technology \r\n\r\nJuhu- Versova Link Road Versova andheri W Mumbai- 400 053\r\n\r\n"	20000
940	Deepti Pawar	Mahavir Education Trust's - Shah and Anchor Kutchhi Engineering College	15000
941	Asmita S. Deshmukh	Excelsior Education Society's K. C. College of Engineering Mith Bunder Road Kopri Thane (E) 400 603.	25000



# Vivekanand Education Society's Institute of Technology

(Affiliated to University of Mumbai, Approved by AICTE & Recognized by Govt. of Maharashtra)

942	Dnyaneshwar Jagan Dhangar	Manjara Charitable Trust's Rajiv Gandhi Institute of Technology Vahu-Versova Link Road Versova andheri W Mumbai- 400 053	15000
943	Prof. Roshni Padate	Fr. Conceicao Rodrigues College of Engineering	25000
944	Ms. DIPALI YOGESH KOSHITI	Fr. Conceicao Rodrigues College of Engineering	25000
945	Dr. Dayanand R. Ingle	Bharati Vidyapeeth's College of Engineering	25000
946	Dr. Rahul Khokale	Aldel Education Trusts St John College of Engineering	25000
947	Mrs. Vidya Sachin Zope	Vivekanand Education Society's Institute of Technology	10000
948	Prof. Kalpita Ajinkya Wagaskar	The Bombay Salesian Society's Don Bosco Institute of Technology	15000
949	Mayura Harshal Gavhane	The Bombay Salesian Society's Don Bosco Institute of Technology	20000
950	Neha Rathi	Mahatma Education Society's Pillai HOC College of Engg. & Technology Educational Campus HOC Colony Rasayani Tal. Khalapur Dist. Raigad.- 410 207	15000
951	Nikhil Raje	Mahatma Education Society's Pillai HOC College of Engg. & Technology Educational Campus HOC Colony Rasayani Tal. Khalapur Dist. Raigad.- 410 207	30000
952	Ms. Rohini Bhosale	Mahatma Education Society's Pillai HOC College of Engg. & Technology Educational Campus HOC Colony Rasayani Tal. Khalapur Dist. Raigad.- 410 207	30000
953	Mandar Ganjapurkar	Excelsior Education Society's K. C. College of Engineering Mith Bunder Road Kopri Thane (E) 400 603.	25000
954	CHITRA TUKARAMJI WASNIK	Lokmanya Tilak Jankalayn Shikshan Sanstha's Lokmanya Tilak College of Engineering Sector No.4 Vikas Nagar Kopar Khairane Navi Mumbai- 400709	30000
955	Prof. Kirti Bhikaji Ahirrao	Vishwaniketans Institute of Management Entrepreneurship and Engineering Technology	15000
956	Shainila Mulla	The Bombay Salesian Society's Don Bosco Institute of Technology	10000
957	Mrs. Sarita P. Ambadekar	K. J. Somaiya Institute of Engineering and Information Technology Somaiya Ayurvihar Complex Eastern Express Highway Sion Mumbai - 400 022.	10000
958	Kalpna Deorukhkar	Fr. Conceicao Rodrigues College of Engineering	30000
959	Sushama Nitin Khanvilkar	Xavier Institute of Engineering	25000
960	UFNA C. S.	Vivekanand Education Society's Institute of Technology	15000
961	RAMCHANDRA SHARAD MANGRULKAR	Shri Vile Parle Kelavani Mandals Dwarkadas J. Sanghvi College of Engineering	15000
962	Kiran Bhowmick	Shri Vile Parle Kelavani Mandals Dwarkadas J. Sanghvi College of Engineering	20000
963	Mr. Vinod N. Alone	Padmabhushan Vasantdada Patil Pratisthans College of Engineering Eastern Express Highway Near Everard Nagar Sion-Trombay Road Mumbai-400 022.	15000
964	Mrs Nazneen Amjad Pendhari	Anjuman-i-Islami's M.H. Saboo Siddik College of Engineering	15000





# Vivekanand Education Society's Institute of Technology

(Affiliated to University of Mumbai, Approved by AICTE & Recognized by Govt. of Maharashtra)

972	Dr. Monika Mangla	Lokmanya Tilak College of Engg	15000
973	Ms. Dakshara Panchal	St. Francis Institute of Technology	15000
974	Prof. Sunil Ghane	Bhartiya Vidya Bhavan's Sardar Patel Institute of Technology	15000
975	Prof. Sharmila Sengupta	Vivekanand Education Society's Institute of Technology	30000
976	Mr. Manoj Dhande	Mahavir Education Trust's - Shah and Anchor Kutchhi Engineering College	15000
1017	Mudra Doshi	Vidya Vikas Education Trust Universal College of Engineering	18000
1018	Swati Nadekarni	Mahavir Education Trust's - Shah and Anchor Kutchhi Engineering College	30000
1019	Dr. G T Thampi	Thadomal Shahani Engineering College	30000
1020	Dr. Minal Lopes	St. Francis Institute of Technology (Engineering College)	30000
1021	Pravin R Patil	"Padmabhushan Vasantidada Patil Pratishthans College of Engineering Eastern Express Highway Near Everard Nagar Nion-Trombay Road Mumbai-400 022."	10000
1022	Sachin Gavhane	Atharva Educational Trust's College of Engineering	35000
1023	Dr. Kamal Shah	Zagdu Singh Charitale Trust's Thakur College of Engineering and Technology	25000
1024	Ms. Sunantha Krishnan	Don Bosco College	20000
1025	Farheen Talib	"Mahatma Education Society's Pitali HOC College of Engg. & Technology Educational Campus HOC Colony Rasayani Tal.Khalapur Dist. Raigad.- 410 207"	30000
1026	Diksha Gautam Kumar	Saraswati Education Society's Saraswati College of Engineering	37000
1027	Abirami Sivaprasad	Mahavir Education Trust's - Shah and Anchor Kutchhi Engineering College	25000
1028	Sampada S. Pinge	Thadomal Shahani Engineering College	40000
1029	Mrs. Vidya Pujari	Vivekanand Education Society's Institute of Technology	20000
1030	Komal Golimbade	"Mahatma Education Society's Pitali HOC College of Engg. & Technology Educational Campus HOC Colony Rasayani Tal.Khalapur Dist. Raigad.- 410 207"	20000
1031	Uday Nayak	Don Bosco College	34000
1032	Vijal Jain	Thadomal Shahani Engineering College	30000



Since 1962

# Vivekanand Education Society's Institute of Technology

(Affiliated to University of Mumbai, Approved by AICTE & Recognized by Govt. of Maharashtra)

1029

University of Mumbai



Research Project No : 1029

NAME OF THE RESEARCHER : Mrs. Vidya Poojari  
LECTURE IN : Information Technology  
AMOUNT SANCTIONED : RS - 20000/-  
CO-INVESTIGATOR : \_\_\_\_\_

Ref No. AAMS/ICD/106 of 2021  
23<sup>rd</sup> July, 2021

To,

Vivekanand Education Society's Institute of  
Technology, Hashu Advani Memorial Complex,  
Collector's Colony, R.C. Marg, Chembur,  
Mumbai-400 074.

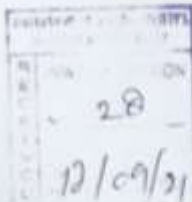
  
28  
12/09/21

Sub - Minor Research Grant Project.

Sir/Madam,

I am directed to inform you that the said proposal has been considered by the University and the research grant as quoted above is sanctioned to the researcher.

The sanctioned amount will be disbursed in two installments. The first installment of 70% of the sanctioned amount will be disbursed within the month of August. The remaining 30% amount will be disbursed up to 31st December, 2021.

The researcher is expected to spend 30% amount initially from his/her own resources to carry out the work.

Further, I am to inform you that the researcher will have to utilize the 100% sanctioned amount on or before 31st December, 2021 and submit original bills/vouchers of the expenditure alongwith Utilization Certificate duly certified by the Principal/ Director/ Head/Institute/University Department of the College to The Deputy Registrar, Accounts Section, Mahatma Phule Bhavan, Vidyanagari, Kalina Campus, University of Mumbai, Mumbai - 400 098.

The report of the research work carried out by the concerned researcher will have to be submitted to the University on or before 31st December, 2021.

The Principal/Head of the Institute are requested to inform the researcher accordingly and arrange to forward his/her undertaking immediately to enable this office to release first installment of the research grant.

Yours faithfully,

  
Assistant Registrar  
(Academic Planning & Development Section)



# Vivekanand Education Society's Institute of Technology

(Affiliated to University of Mumbai, Approved by AICTE & Recognized by Govt. of Maharashtra)

1037	Satishkumar L Varma	Mahatma Education Society's Pillai's College of Architecture Dr. K.M. Vasudevan Pillai's Campus Sector 10 16 New Panvel - 410206	40000
1038	Shrinidhi Gindi	Anjuman-4-Islami's M.H. Saboo Siddik College of Engineering	30000
1039	Medha Nitin Kulkarni	Padmabhushan Vasantdada Patil Pratisthans College of Engineering Eastern Express Highway Near Everard Nagar Sion-Trombay Road Mumbai-400 022.	20000
1040	Mrs. Vijaya Pinjarkar(Khirodkar)	K. J. Somaiya Institute of Engineering and Information Technology Somaiya Ayurvihar Complex Eastern Express Highway Sion Mumbai - 400 022.	25000
1041	Prof. Vijaya Sagvekar	Vasantdada Patil Pratisthan's Manohar Phalke College of Architecture	25000
1042	Dr. Irfan Siddavatam	K.J. Somaiya College of Engineering	40000
1043	Mrs. Vricha Chavan	K. J. Somaiya Institute of Engineering and Information Technology	15000
1044	Dr. Gautam Borkar	Ramrao Adik Edu. Soc., Ramrao Adik Inst. Of Technology	30000
1045	Mrs. Anita Patil	Ramrao Adik Edu. Soc., Ramrao Adik Inst. Of Technology	15000
1046	Rupali Pashete	Shri. L. R. Tiwari College of Engg.	15000
1047	Mr. Sainath T. Patil	Vidyavardhini's College of Engineering and Technology Vidyavardhini's College Campus	30000
1048	Ms. Madhavi H. Waghmare	Vidyavardhini's College of Engineering and Technology Vidyavardhini's College Campus	10000
1049	Ms. Asha Bharambe	Vivekanand Education Society's Institute of Technology	30000
1050	Ms. Archana Satish Chaugule	Shah & Anchor kutchhi Engg. College	15000
1051	Ms. Jayshree Hagude	Vivekanand Edu. Inst. Of Tech.	15000
1052	Dr. Bhushan Jadhav	Thadomal Shahani Engg. College	25000
<b>Electronics Engineering (Apex Committee)</b>			
Project No.	Name of Principal Investigator	College name	Grant Sanction
1053	Mrs. Sheetal Girish Jagtap	K. J. Somaiya Institute of Engineering and Information Technology Somaiya Ayurvihar Complex Eastern Express Highway Sion Mumbai - 400 022.	35000
1054	Kranti Kiran Wagle	Fr. Conceicao Rodrigues College of Engineering	30000
1055	Ms Medha Sanjay Asurlekar	K. J. Somaiya Institute of Engineering and Information Technology Somaiya Ayurvihar Complex Eastern Express Highway Sion Mumbai - 400 022.	35000
1056	Mrs. Priya Deshpande	Bhartiya Vidya Bhavani's Sardar Patel Institute of Technology	20000
1057	Dr. Milind Uttam Nemade	K. J. Somaiya Institute of Engineering and Information Technology Somaiya Ayurvihar Complex Eastern Express Highway Sion Mumbai - 400 022.	35000
1058	Prof. Payal Shah	Bhartiya Vidya Bhavani's Sardar Patel Institute of Technology	15000
1059	Dr. Surendra Singh Rathod	Bhartiya Vidya Bhavani's Sardar Patel Institute of Technology	25000

1060	Chaitali Nandkumar Mahajan	Anjuman-4-Islami's M.H. Saboo Siddik College of Engineering	30000
1061	K.T.Talele	Bhartiya Vidya Bhavani's Sardar Patel Institute of Technology	30000
1062	Hemant Kasturilwale	Zagdu Singh Charitale Trust's Thakur College of Engineering and Technology	10000
1063	Mr. Manoj Suresh Gofane	Ramrao Adik Institute of Technology Sector-7 Dr. D. Y. Patil Vidyanagar Phase-I Nerul Navi Mumbai - 400 705.	40000



# Vivekanand Education Society's Institute of Technology

(Affiliated to University of Mumbai, Approved by AICTE & Recognized by Govt. of Maharashtra)

1105	Mrs. Arti R. Sawant	Vivekanand Education Society's Institute of Technology	15000
1106	KAUSHAL K PANDEY	Shivajirao S. Jondhale College of Engineering	10000
1107	Sonal Hutke	South Indian Education Society's Graduate School of Technology	20000
1108	Ms. T.P. Vinutha	Mahavir Education Trust's - Shah and Anchor Kutchhi Engineering College	25000
1109	Savitha S Upadhye	Agnel Charitable Trust's Fr. Conceicao Rodrigues Institute of Technology	20000
1110	Dr. Pranali Choudhari,	Agnel Charitable Trust's Fr. Conceicao Rodrigues Institute of Technology	40000
1111	Mrs Nuzrat Ansari	Vivekanand Education Society's Institute of Technology	45000
1112	Ms. Quantiah Shaikh	St. Francis Institute of Technology (Engineering College)	25000
1113	Ms. Jovita Serrao	St. Francis Institute of Technology (Engineering College)	40000
1114	Dr. Maniroja.M.Edinburgh	Thadomal Shahani Engineering College	25000
1115	Dr. Sanjeev Kumar Srivastava	\Mahatma Education Society's Pillai College of Engineering \r\n Dr. K. M. Vasudevan Pillai Campus Sector 16 New Panvel Navi Mumbai- 410206 \r\n	25000
1116	Megha M. Kolhekar	Agnel Charitable Trust's Fr. Conceicao Rodrigues Institute of Technology	25000
1117	Prof. Smita A. Lonkar	Shivajirao S. Jondhale College of Engineering	35000
1118	Prof. Sneha Burnase	Saraswati Education Society's Saraswati College of Engineering	20000
1119	Mr. Somnath P. Tandale	\Ramrao Adik Institute of Technology Sector-7 Dr. D. Y. Patil Vidyanagar Phase-I Nerul Navi Mumbai - 400 706\r\n	25000
1120	Poonam Sonar	Manjara Charitable Trust's Rajiv Gandhi Institute of Technology \r\nLulu- Versova Link Road Versova andheri W Mumbai- 400 053\r\n	20000
1121	Bhushan S. Deore	\Ramrao Adik Institute of Technology Sector-7 Dr. D. Y. Patil Vidyanagar Phase-I Nerul Navi Mumbai - 400 706\r\n	40000
1122	Jithin Saji Isaac	The Bombay Salesian Society's Don Bosco Institute of Technology	25000
1123	Karishma Raut	Late Shri. Vishnu Waman Thakur Charitable Trust VIVA Institute of Technology	35000
1124	Mrs.Jyoti Dawkhari	Vivekanand Education Society's Institute of Technology	25000
1125	Mrs.Sunita S. Chavan(Munde)	Lokmanya Tilak Jankalayn Shikshan Sanstha's Lokmanya Tilak College of Engineering Sector No.4 Vikas Nagar Kopar Khairane Navi Mumbai- 400709	25000
1126	Amol Shashikant Sankpal	Anjuman-i-Islami's M.H. Saboo Siddik College of Engineering	40000
1127	Madhura Manodaya Shirodkar	Xavier Institute of Engineering	35000
1128	SUMITA GUPTA	Excelsior Education Society's K. C. College of Engineering Mith Bunder Road Kopri Thane (E) & 400 603.	16000
1129	Mrs. Shilpa Vikas Shinde	Vishwaniketan's Institute of Management Entrepreneurship and Engineering Technology	20000
1130	Dr. Mrs. Saylee Milind Gharge	Vivekanand Education Society's Institute of Technology	35000





# Vivekanand Education Society's Institute of Technology

(Affiliated to University of Mumbai, Approved by AICTE & Recognized by Govt. of Maharashtra)

1105	Mrs. Arti R. Sawant	Vivekanand Education Society's Institute of Technology	15000
1106	KAUSHAL K PANDEY	Shivajirao S. Jondhale College of Engineering	10000
1107	Sonal Hutke	South Indian Education Society's Graduate School of Technology	20000
1108	Ms. T.P. Vinutha	Mahavir Education Trust's - Shah and Anchor Kutchhi Engineering College	25000
1109	Savitha S Upadhye	Agnel Charitable Trust's Fr. Conceicao Rodrigues Institute of Technology	20000
1110	Dr. Pranali Choudhari,	Agnel Charitable Trust's Fr. Conceicao Rodrigues Institute of Technology	40000
1111	Mrs Nuzrat Ansari	Vivekanand Education Society's Institute of Technology	45000
1112	Ms. Quantiah Shaikh	St. Francis Institute of Technology (Engineering College)	25000
1113	Ms. Jovita Serrao	St. Francis Institute of Technology (Engineering College)	40000
1114	Dr. Maniroja.M.Edinburgh	Thadomal Shahani Engineering College	25000
1115	Dr. Sanjeev Kumar Srivastava	\Mahatma Education Society's Pillai College of Engineering \r\n Dr. K. M. Vasudevan Pillai Campus Sector 16 New Panvel Navi Mumbai- 410206 \r\n	25000
1116	Megha M. Kolhekar	Agnel Charitable Trust's Fr. Conceicao Rodrigues Institute of Technology	25000
1117	Prof. Smita A. Lonkar	Shivajirao S. Jondhale College of Engineering	35000
1118	Prof. Sneha Burnase	Saraswati Education Society's Saraswati College of Engineering	20000
1119	Mr. Somnath P. Tandale	\Ramrao Adik Institute of Technology Sector-7 Dr. D. Y. Patil Vidyanagar Phase-I Nerul Navi Mumbai - 400 705\r\n	25000
1120	Poonam Sonar	Manjara Charitable Trust's Rajiv Gandhi Institute of Technology \r\nLulu- Versova Link Road Versova andheri W Mumbai- 400 053\r\n	20000
1121	Bhushan S. Deore	\Ramrao Adik Institute of Technology Sector-7 Dr. D. Y. Patil Vidyanagar Phase-I Nerul Navi Mumbai - 400 705\r\n	40000
1122	Jithin Saji Isaac	The Bombay Salesian Society's Don Bosco Institute of Technology	25000
1123	Karishma Raut	Late Shri. Vishnu Waman Thakur Charitable Trust VIVA Institute of Technology	35000
1124	Mrs.Jyoti Dawkhari	Vivekanand Education Society's Institute of Technology	25000
1125	Mrs.Sunita S. Chavan(Munde)	Lokmanya Tilak Jankalayn Shikshan Sanstha's Lokmanya Tilak College of Engineering Sector No.4 Vikas Nagar Kopar Khairane Navi Mumbai- 400709	25000
1126	Amol Shashikant Sankpal	Anjuman-i-Islami's M.H. Saboo Siddik College of Engineering	40000
1127	Madhura Manodaya Shirodiar	Xavier Institute of Engineering	35000
1128	SUMITA GUPTA	Excelsior Education Society's K. C. College of Engineering Mith Bunder Road Kopri Thane (E) & 400 603.	16000
1129	Mrs. Shilpa Vikas Shinde	Vishwaniketan's Institute of Management Entrepreneurship and Engineering Technology	20000
1130	Dr. Mrs. Saylee Milind Gharge	Vivekanand Education Society's Institute of Technology	35000

The Dynamic Daily Newspaper of Navi Mumbai

# Newsband

21 November 2019 THURSDAY  
VOL. 13 • ISSUE 169 PAGES 12 • PRICE ₹ 1  
RNI No. MAHEN/2007/21778 POSTAL REGN. NO. M

## NMMC awards Colleges for best disaster management projects



**NAVI MUMBAI:** The Navi Mumbai Municipal Corporation (NMMC) and the United Nations Develop-

ment Programme (UNDP) had organised a unique competition for the Colleges on Disaster Management. The team from each College had to showcase their creativity and originality with their unique concepts for combating disaster and the steps that can be

taken by the governing bodies during natural calamities.

54 students from various engineering colleges from Navi Mumbai, Panvel, Thane and Mumbai had submitted projects. Out of these, six projects were selected for their concepts.

IIT, Mumbai pre-

sented a sample project 'Portable Operation Room for Disaster' that is very easy to navigate and use for emergency operations in the disaster affected areas. Vivekananda Education Society's Institute of Technology, Chembur's

Contd. on pg. 2

**NEWS IN BRIEF**

### NMMC awards Colleges...

Contd. from pg. 1

project was on 'Lake cleaning'; Ramrao Adik's Institution of Technology, DY Patil College Nerul presented 'Human Detector - Snake Robot' project; M.H. Sabu Siddiqui College of Engineering (The two student groups independently performed chemical disaster project experiments on 'Human Rescue Robot' and 'Hazard's Material Detection Using Raspberry Pi'. The students of SIES, Nerul, presented an ingenious experiment to propa-

gate the message 'Accident Mitigator'.

The winners were honoured by Mayor Jayawant Sutar at the general body meeting of the Municipal Corporation along with the Principals of the Colleges, and the professors who guided the project. On this occasion the Deputy Mayor, Mandakini Mhatre, Municipal Commissioner Annasaheb Misal, Chairman of Standing Committee Naveen Gavte, House Leader Ravindra Ithape, Leader of Opposition Vijay Chaugule, Avinash Lad, Dr. Jayaji Nath, and others were present.



Since 1962

# Vivekanand Education Society's Institute of Technology

(Affiliated to University of Mumbai, Approved by AICTE & Recognized by Govt. of Maharashtra)

BRANCH : Janakalyan Sahakari Bank Ltd., SHIVDI SOCIETY  
 USER : UPN797  
**जनकल्याण सहकारी बँक लि.**  **JANAKALYAN SAHAKARI BANK**  
 CHEMBUR (शेडयूल्ड बँक) (Scheduled I)  
 CITY : MUMBAI  
 PIN CODE : 400071 Fax : 25246737  
 PHONE #1 : 25244504 Phone #2 : 0  
 RUN DATE : 02/01/2019 16:42:14\*\*\*\*\* STATEMENT OF ACCOUNTS \*\*\*\*\* PAGE : 3

Date	Particulars	Instruments	Dr Amount	Cr Amount	Total Amount Dr/Cr
18/03/2019	CA 1093 ON SAI ENTERPSIES	122548	33,402.00		81,24,865.45 CR
18/03/2019	NEFT NAVIMUMBAI MUNICIPAL			14,999.00	81,39,864.45 CR

## The results of the Competition related to Students' Concepts of Disaster Management declared

**By Chandreshkhar Hazare**  
 NAMI MUMBAI: Navi Mumbai Municipal Corporation and United Nations



Development Program had jointly organized for Engineering Degree Colleges's students a competition where they had to come up with their concepts on the issue related to disaster management. The committee then selected 10 out of 11 proposals of

Entry No.	Name of the College	Project Proposal - Title	Total Marks	Rank
54	IT Mumbai	Road Accident Response Management System	73	1
47	Vivekanand Education Society's Institute of Technology, Chembur	Search	72	2
52	V/ITI	Pushpac	70	3
25	Ramrao Adik Institute of Technology, Nerul	Human Detector (Snake Robot)	69	4
21	MHSSCOE	Human Rescue Robot	68	5
26	IT Mumbai	Portable Operation room for Disaster Affected Areas	68	5
9	PV's HOC College of Engineering & Technology	Automatic Accident Detection & Notification System	55	6
34	MHSSCOE	Hazardous Material Detection using Raspberry Pi	53	7
2	SIES	Accident Mitigator	51	8
41	IT Mumbai	Flood Monitoring App based Estimation of Water Level & mapping by Crowd sourcing	50	9
53	V/ITI	avtra	50	9

these concepts and these selected ones

will get Rs 50000 prize from NMMC. Here

are the marks obtained by 11 proposals:





# Vivekanand Education Society's Institute of Technology

(Affiliated to University of Mumbai, Approved by AICTE & Recognized by Govt. of Maharashtra)

University of Mumbai



Research Project No:162

NAME OF THE RESEARCHER : Mr. Ajinkya Anandgopal Valanjoo  
LECTURE IN : Electronics and Telecommunication  
AMOUNT SANCTIONED : Rs.25000 /-

Ref No. APD/237/601 of 2019  
27th March, 2019

To,  
The Principal,  
Vivekanand Education Society's Institute of Technology  
Hashu Advani Memorial Complex, VES Campus II, Collector Colony, Chembur - 400 074

Sub: - Minor Research Grant Project.

Sir/Madam,

I am directed to inform you that the said proposal has been considered by the University and the research grant as quoted above is sanctioned to the researcher.

The sanctioned amount will be disbursed in two installments. The first installment of 40% of the sanctioned amount will be disbursed within the month of March. The remaining 60% amount will be disbursed up to 31st August, 2019.

The researcher is expected to spend 60% amount initially from his/her own resources to carry out the work.

Further, I am to inform you that the researcher will have to utilize the 40% sanctioned amount on or before 31st March, 2019 and submit original bills/vouchers of the expenditure alongwith Utilization Certificate duly certified by the Principal/ Director/ Head/Institute/University Department of the College to the Accounts Section of University.

Please note that 60% balance amount out of sanctioned grant will be released after presentation of your proposal & final approval of the committee. You need to submit utilization certificate after presentation of your research and final approval of 60% grant including bills/vouchers/receipts in original through University Accounts Section.

The report of the research work carried out by the concerned researcher will have to be submitted to the University on or before 31st August 2019.

The Principal/Head of the Institute are requested to inform the researcher accordingly and arrange to forward his/her undertaking immediately to enable this office to release first installment of the research grant.

Yours faithfully,

*S. S. Sawant*  
Assistant Registrar

(Academic Planning & Development)

Scanned by CamScanner





# Vivekanand Education Society's Institute of Technology

(Affiliated to University of Mumbai, Approved by AICTE & Recognized by Govt. of Maharashtra)



## ROYAL ELECTRONICS

Mob:- 9324088098 / 022-25211248

**ALL TYPES OF COMPUTER & LAPTOP ACCESSORIES  
T.V., LCD, LED, A/C, REMOTE CONTROL & SPARE PARTS**

Shop No. 8-A, 82 Sai Deep Shopping Center, Opp. Vaishali Hotel, N.G. Acharya Marg,  
Near Chembur Rly. Station, Chembur (E), Mumbai - 400071.

No. **2346** Date: 9/3/15

Name: Ajinkya A. Valangoo

Qty.	Description	Rate	Amount
1	STM 32F103C8T6	155	155
2	INA219	115	230
2	RFM69HW	150	300
1	Atiny 85	105	105
1	usb m/ plug	110	110
1	Lipo fuel gauge	165	165
10	4067 IC	35	350
10	Buser piezo	20	200
10	RF module.	152	1520
	SGSI 9/		282
	CGSI 9/		282
Good once sold will not be taken back			
GSTIN 27AOFPS1207422		TOTAL	3699/=

Warranty will be given by service center  
No Warranty for Case / Converter / Adaptor  
Physical Damage or Burning

For Royal Electronics



# Vivekanand Education Society's Institute of Technology

(Affiliated to University of Mumbai, Approved by AICTE & Recognized by Govt. of Maharashtra)

## ROYAL ELECTRONICS

Mob:- 9324088098 / 022-25211248

**ALL TYPES OF COMPUTER & LAPTOP ACCESSORIES  
T.V., LCD, LED, A/C, REMOTE CONTROL & SPARE PARTS**

Shop No. 8-A, 82 Sai Deep Shopping Center, Opp. Vaishali Hotel, N.G. Acharya Marg,  
Near Chembur Rly. Station, Chembur (E), Mumbai - 400071.

No. **2331** Date: 7/3/19

Name: Ajinkya A. Valayoo

Qty.	Description	Rate	Amount
10	Arduino nano	150	1500
10	Step up Converter	30	300
10	Lipo fuel gauge	165	1650
	SGSI 9%.		310.5
	CGSI 9%.		310.5
		<b>TOTAL</b>	<u>4071</u> =

Good once sold will not be taken back

GSTIN : 27AOFPS1207N1ZP

Warranty will be given by service center  
No Warranty for Cable / Converter / Adapter  
Physical Damage & Burning

For Royal Electronics



# Vivekanand Education Society's Institute of Technology

Since 1962

(Affiliated to University of Mumbai, Approved by AICTE & Recognized by Govt. of Maharashtra)



## ROYAL ELECTRONICS

Mob:- 9324088098 / 022-25211248

**ALL TYPES OF COMPUTER & LAPTOP ACCESSORIES  
T.V., LCD, LED, A/C, REMOTE CONTROL & SPARE PARTS**

Shop No. 8-A, 82 Sai Deep Shopping Center, Opp. Vaishali Hotel, N.G. Acharya Marg,  
Near Chembur Rly. Station, Chembur (E), Mumbai - 400071.

No. **2323**

Date: 5/3/19



Name: AJINKYA A. VALANJOO

Qty.	Description	Rate	Amount
2	MQ 135 module	275	550
2	MQ 7 CO Sensor	250	500
1	MQ 9 Gas Sensor	375	375
1	USB TO TTL module	330	330
3	Resistor		12
1	MQ 2 Gas Sensor		225
	SGST 9%		179
	CGST 9%		179
<b>TOTAL</b>			<b>2350</b> =

Goods sold will not be taken back

GSTIN : 27AOFPS1207N1

Warranty given by service center  
No Warranty for Cable / Converter / Adapter  
Physical Damage & Burning

For Royal Electronics





# Vivekanand Education Society's Institute of Technology

(Affiliated to University of Mumbai, Approved by AICTE & Recognized by Govt. of Maharashtra)

## MINOR RESEARCH REPORT

### EXPENDITURE

**TITLE OF THE PROJECT: AIR QUALITY MONITORING SYSTEM FOR CHEMBUR  
AREA(USING A WIRELESS SENSOR NETWORK)**

**Principal Investigator: Mr. Ajinkya A. Valanjoo (Project No:162)**

Sr.No	Bill No.	Date of bill	Particular/Purpose	Amount (Rs)
1	2323	5/3/2019	MQ135 Gas Sensor Module(2 Nos)	550
2	2323	5/3/2019	MQ7 CO Sensor(2 Nos)	500
3	2323	5/3/2019	MQ9 gas Sensor(1 Nos)	375
4	2323	5/3/2019	USB to TTL Serial Converter Adapter(1 Nos)	330
5	2323	5/3/2019	Power Resistors(3 Nos)	12
6	2323	5/3/2019	MQ2 gas sensor(1 Nos)	225
7	2331	7/3/2019	Arduino nano(10 Nos)	1500
8	2331	7/3/2019	Step Up Converter(10 Nos)	300
9	2331	7/3/2019	LiPo Fuel Gauge(10 Nos)	1650
10	2346	9/3/2019	STM32 F103C8T6(1 Nos)	155
11	2346	9/3/2019	INA219(2 Nos)	230
12	2346	9/3/2019	RFM69HW(2 Nos)	300
13	2346	9/3/2019	ATtiny85(1 Nos)	105
14	2346	9/3/2019	USB male plug(1 Nos)	110
15	2346	9/3/2019	LiPo fuel gauge(1 Nos)	165
16	2346	9/3/2019	A/D Multiplexer	350





# Vivekanand Education Society's Institute of Technology

(Affiliated to University of Mumbai, Approved by AICTE & Recognized by Govt. of Maharashtra)

			CD74HC4067(10Nos)	
17	2346	9/3/2019	Piezo element buzzer(10 Nos)	200
18	2346	9/3/2019	RFM 69 HW(10 Nos)	1520
	2323	5/3/2019	CGST & SGST(18%)	358
	2331	7/3/2019	CGST & SGST(18%)	621
	2346	9/3/2019	CGST & SGST(18%)	564
			Total	10120





# Vivekanand Education Society's Institute of Technology

(Affiliated to University of Mumbai, Approved by AICTE & Recognized by Govt. of Maharashtra)



## Vivekanand Education Society's Institute of Technology

(Affiliated to University of Mumbai, Approved by AICTE & Recognized by Govt. of Maharashtra)

Since 1962  
Dr. (Mrs.) J. M. Nair  
M. Tech, Ph.D. (IT) &  
Principal  
Ref No: VESIT/AMN/AN/3466/2018-2019

Date: 23/03/2019

### Utilization Certificate

Certified that the sanctioned grant of Rs. 25,000/- (Rupees Twenty Five Thousand only) from the University Of Mumbai, under the scheme of support for Minor Research Grant Project entitled "Air Quality Monitoring System for Chembur Area (Using a Wireless Sensor Network)" by Mr. Ajinkya A. Valanjoo Rs. 10,000/- will be received as the first installment from the university. Rs. 10,120/- (Ten Thousand One Hundred and Twenty only) has been utilized for the purpose and the bills have been submitted to the University accounts section for which it has been sanctioned and in accordance with the terms and conditions laid down by the university.

University letter No: APD/ICD/2018-19/593  
Mobile No. 9773273165

Dated: 16<sup>th</sup> March, 2019

  
Mr. Ajinkya A. Valanjoo  
Principal Investigator



  
Principal  
PRINCIPAL,  
VIVEKANAND EDUCATION SOCIETY'S  
INSTITUTE OF TECHNOLOGY  
PLAZA: ADVANI MEMORIAL COMPLEX,  
COLLECTOR'S COLONY, CHEMBUR,  
MUMBAI-400 074, INDIA.

Nishu Advani Memorial Complex, Collector's Colony, Chembur, Mumbai - 400 074, INDIA.  
Tel: +91 22 6153 2532 / Fax: +91 22 6153 2555 | Email: vest@vsi.com / principal.vest@ves.ac.in • Website: www.ves.ac.in/vest



# Vivekanand Education Society's Institute of Technology

(Affiliated to University of Mumbai, Approved by AICTE & Recognized by Govt. of Maharashtra)

University of Mumbai



Research Project No:159

NAME OF THE RESEARCHER  
LECTURE IN  
AMOUNT SANCTIONED

: Mrs. Neeta Pankaj Chavan  
: Electronics and Telecommunication  
: Rs.25000/-

Ref No. APD/237/601 of 2019  
27th March, 2019

To,  
The Principal,  
Vivekanand Education Society's Institute of Technology  
Hashu Advani Memorial Complex,  
VES Campus II, Collector Colony,  
Chembur - 400 074

Sub: - Minor Research Grant Project.

Sir/Madam,

I am directed to inform you that the said proposal has been considered by the University and the research grant as quoted above is sanctioned to the researcher.

The sanctioned amount will be disbursed in two installments. The first installment of 40% of the sanctioned amount will be disbursed within the month of March. The remaining 60% amount will be disbursed up to 31st August, 2019.

The researcher is expected to spend 60% amount initially from his/her own resources to carry out the work.

Further, I am to inform you that the researcher will have to utilize the 40% sanctioned amount on or before 31st March, 2019 and submit original bills/vouchers of the expenditure alongwith Utilization Certificate duly certified by the Principal/ Director/ Head/Institute/University Department of the College to the Accounts Section of University.

Please note that 60% balance amount out of sanctioned grant will be released after presentation of your proposal & final approval of the committee. You need to submit utilization certificate after presentation of your research and final approval of 60% grant including bills/vouchers/receipts in original through University Accounts Section.

The report of the research work carried out by the concerned researcher will have to be submitted to the University on or before 31st August 2019.

The Principal/Head of the Institute are requested to inform the researcher accordingly and arrange to forward his/her undertaking immediately to enable this office to release first installment of the research grant.

Yours faithfully,

*Stujawan*  
Assistant Registrar

(Academic Planning & Development)



# Vivekanand Education Society's Institute of Technology

(Affiliated to University of Mumbai, Approved by AICTE & Recognized by Govt. of Maharashtra)



(3)

NAME OF THE RESEARCHER  
LECTURE IN  
AMOUNT SANCTIONED

Research Project No:160

: Mrs.Himali Patel  
: Electronics and Telecommunication  
: Rs.20000 /-

Ref No. APD/237/601 of 2019  
27th March, 2019

To,  
The Principal,  
Vivekanand Education Society's Institute of Technology  
Hashu Advani Memorial Complex,  
VES Campus II, Collector Colony,  
Chembur - 400 074

Sub: - Minor Research Grant Project.

Sir/Madam,

I am directed to inform you that the said proposal has been considered by the University and the research grant as quoted above is sanctioned to the researcher.

The sanctioned amount will be disbursed in two installments. The first installment of 40% of the sanctioned amount will be disbursed within the month of March. The remaining 60% amount will be disbursed up to 31st August, 2019.

The researcher is expected to spend 60% amount initially from his/her own resources to carry out the work.

Further, I am to inform you that the researcher will have to utilize the 40% sanctioned amount on or before 31st March, 2019 and submit original bills/vouchers of the expenditure alongwith Utilization Certificate duly certified by the Principal/ Director/ Head/Institute/University Department of the College to the Accounts Section of University.

Please note that 60% balance amount out of sanctioned grant will be released after presentation of your proposal & final approval of the committee. You need to submit utilization certificate after presentation of your research and final approval of 60% grant including bills/vouchers/receipts in original through University Accounts Section.

The report of the research work carried out by the concerned researcher will have to be submitted to the University on or before 31st August 2019.

The Principal/Head of the Institute are requested to inform the researcher accordingly and arrange to forward his/her undertaking immediately to enable this office to release first installment of the research grant.

Yours faithfully,





# Vivekanand Education Society's Institute of Technology

(Affiliated to University of Mumbai, Approved by AICTE & Recognized by Govt. of Maharashtra)

University of Mumbai



Research Project No:163

**NAME OF THE RESEARCHER** : Shobhit K. Klundare  
**LECTURE IN** : Electronics and Telecommunication  
**AMOUNT SANCTIONED** : Rs.25000 /-

Ref No. APD/237/601of 2019  
27th March, 2019

To,  
The Principal,  
Vivekanand Education Society's Institute of Technology  
Hashu Advani Memorial Complex,  
VES Campus II, Collector Colony,  
Chembur - 400 074

**Sub: - Minor Research Grant Project.**

Sir/Madam,

I am directed to inform you that the said proposal has been considered by the University and the research grant as quoted above is sanctioned to the researcher.

The sanctioned amount will be disbursed in two installments. The first installment of 40% of the sanctioned amount will be disbursed within the month of March. The remaining 60% amount will be disbursed up to 31st August, 2019.

The researcher is expected to spend 60% amount initially from his/her own resources to carry out the work.

Further, I am to inform you that the researcher will have to utilize the 40% sanctioned amount on or before 31st March, 2019 and submit original bills/vouchers of the expenditure alongwith Utilization Certificate duly certified by the Principal/ Director/ Head/Institute/University Department of the College to the Accounts Section of University.

Please note that 60% balance amount out of sanctioned grant will be released after presentation of your proposal & final approval of the committee. You need to submit utilization certificate after presentation of your research and final approval of 60% grant including bills/vouchers/receipts in original through University Accounts Section.

The report of the research work carried out by the concerned researcher will have to be submitted to the University on or before 31st August 2019.

The Principal/Head of the Institute are requested to inform the researcher accordingly and arrange to forward his/her undertaking immediately to enable this office to release first installment of the research grant.

Yours faithfully,  
*S. S. S. S.*  
Assistant Registrar  
(Academic Planning & Development)



# Vivekanand Education Society's Institute of Technology

Since 1962

(Affiliated to University of Mumbai, Approved by AICTE & Recognized by Govt. of Maharashtra)



Lifna C S <lifna.cs@ves.ac.in>

## Fwd: Welcome to the AI for Earth Community

Nupur Giri <nupur.giri@ves.ac.in>  
To: Lifna C S <lifna.cs@ves.ac.in>

Sat, Nov 10, 2018 at 4:00 PM

----- Forwarded message -----

From: **AI for Earth Grants** <AI4EGrants@microsoft.com>  
Date: Thu, Nov 8, 2018 at 9:27 AM  
Subject: Welcome to the AI for Earth Community  
To: "nupur.giri@ves.ac.in" <nupur.giri@ves.ac.in>  
Cc: AI for Earth Grants <AI4EGrants@microsoft.com>

Dear Nupur,

**Congratulations, and welcome to the AI for Earth community!** We are excited to share that your application has been selected for an AI for Earth Microsoft Azure Compute Grant. Through this award, you will receive a sponsored Microsoft Azure account. We are granting you credits for Azure consumption up to **\$10,000 USD**, to be utilized within one year. Please note:

- The award will expire when you reach this level of cumulative usage or you reach the expiration date, **whichever occurs first**. Your expiration date will be confirmed upon activation.
- You will receive monthly statements letting you know the dollar amount of Azure that has been consumed and the dollar balance remaining; you can check usage anytime by logging into the [Azure portal](#).
- To track project progress, we require that you:
  - Answer quarterly surveys on progress
  - Submit a final report on results

### Next Steps:

- **Please complete this [Welcome Form](#) by November 12, 2018** - This is very important!
- After you attend the **mandatory Grantee Onboarding Webinar** (outlined in the Welcome Survey above), you will receive an email from [azdesk@microsoft.com](mailto:azdesk@microsoft.com) with more details and instructions on how to activate your account.
- Share any plans you may have around amplifying your AI4E award (including media outreach, press release, social media, etc.) with Michelle Lancaster, [milanca@microsoft.com](mailto:milanca@microsoft.com)

Congratulations again, and we are very happy to support your work in advancing environmental sustainability!

Best,

**Bonnie Lei**

AI for Earth Project Manager +1 4257068003 x68003  
Environmental Sustainability [bonnie.lei@microsoft.com](mailto:bonnie.lei@microsoft.com)





# Vivekanand Education Society's Institute of Technology

Since 1962

(Affiliated to University of Mumbai, Approved by AICTE & Recognized by Govt. of Maharashtra)



Lifna C S <lifna.cs@ves.ac.in>

## Fwd: Welcome to the AI for Earth Community

Gresha Bhatia <gresha.bhatia@ves.ac.in>  
To: Lifna C S <lifna.cs@ves.ac.in>, Gresha Bhatia <gresha.bhatia@ves.ac.in>

Sat, Mar 23, 2019 at 2:19 AM

----- Forwarded message -----

From: DEVENDRA CHAUDHARI <2015devendra.chaudhari@ves.ac.in>  
Date: Thu, Nov 8, 2018, 10:01 AM  
Subject: Fwd: Welcome to the AI for Earth Community  
To: Gresha Bhatia <gresha.bhatia@ves.ac.in>, SANKET PARATKAR <2015sanket.paratkar@ves.ac.in>, AKSHAYA PATIL <2015akshaya.patil@ves.ac.in>, PANKAJ AHUJA <2015pankaj.ahuja@ves.ac.in>

----- Forwarded message -----

From: **AI for Earth Grants** <AI4EGrants@microsoft.com>  
Date: Thu, Nov 8, 2018, 9:33 AM  
Subject: Welcome to the AI for Earth Community  
To: 2015devendra.chaudhari@ves.ac.in <2015devendra.chaudhari@ves.ac.in>  
Cc: AI for Earth Grants <AI4EGrants@microsoft.com>

Dear Devendra ,

**Congratulations, and welcome to the AI for Earth community!** We are excited to share that your application has been selected for an AI for Earth Microsoft Azure Compute Grant. Through this award, you will receive a sponsored Microsoft Azure account. We are granting you credits for Azure consumption up to **\$10,000 USD**, to be utilized within one year. Please note:

- The award will expire when you reach this level of cumulative usage or you reach the expiration date, **whichever occurs first**. Your expiration date will be confirmed upon activation.
- You will receive monthly statements letting you know the dollar amount of Azure that has been consumed and the dollar balance remaining; you can check usage anytime by logging into the [Azure portal](#).
- To track project progress, we require that you:
  - Answer quarterly surveys on progress
  - Submit a final report on results

### Next Steps:

- **Please complete this [Welcome Form](#) by November 12, 2018** - This is very important!
- After you attend the **mandatory Grantee Onboarding Webinar** (outlined in the Welcome Survey above), you will receive an email from [azdesk@microsoft.com](mailto:azdesk@microsoft.com) with more details and instructions on how to activate your account.
- Share any plans you may have around amplifying your AI4E award (including media outreach, press release, social media, etc.) with Michelle Lancaster, [milanca@microsoft.com](mailto:milanca@microsoft.com)

Congratulations again, and we are very happy to support your work in advancing environmental sustainability!

Best,

Bonnie Lei



# Vivekanand Education Society's Institute of Technology

(Affiliated to University of Mumbai, Approved by AICTE & Recognized by Govt. of Maharashtra)

Esri software licenses for ArcGIS Pro and ArcGIS Enterprise can be provided for the one year term of the grant.  
Please note:

- Award details will be determined by working with each grantee directly
- Your licenses will expire in one year
- Your use of the software is subject to the standard software licenses for the products.

Next steps:

- Please contact the appropriate representative to obtain access to the Esri Licensing award:
  - Educational Institutions please contact Ann Masangcay [amasangcay@esri.com](mailto:amasangcay@esri.com)
  - Nonprofit Organizations please contact Steve Beckwith [SBeckwith@esri.com](mailto:SBeckwith@esri.com)
  - Start-up Institutions please contact [startups@esri.com](mailto:startups@esri.com)
- If you already have access to Esri technology through an existing agreement, Esri will facilitate license distribution from the Educational Site License or Nonprofit Enterprise Agreement administrator.
- If you need access to Esri licenses, complimentary term licenses for ArcGIS Professional and ArcGIS Enterprise will be provided by the Esri support contacts listed above.

---

### 3 attachments

 Microsoft [image002.jpg](#)  
2K

 [3 Page AI4Earth Proposal-Water Supply Management and Catchment Control in Drought Prone Regions of Rural India.pdf](#)  
190K

 [Detailed AI for Earth 2018 Proposal - Water Supply Management and Catchment Control in Drought Prone Regions of Rural India.pdf](#)  
341K





# Vivekanand Education Society's Institute of Technology

Since 1962

(Affiliated to University of Mumbai, Approved by AICTE & Recognized by Govt. of Maharashtra)



Lifna C S <lifna.cs@ves.ac.in>

## Fwd: Welcome to the AI for Earth Community : Water Supply Management and Catchment Control in Drought Prone Regions of Rural India

1 message

Richard Joseph <richard.joseph@ves.ac.in>  
To: Lifna C S <lifna.cs@ves.ac.in>  
Cc: Nupur Giri <nupur.giri@ves.ac.in>

Sat, Nov 10, 2018 at 3:43 PM

----- Forwarded message -----

From: **AI for Earth Grants** <AI4EGrants@microsoft.com>  
Date: Thu 8 Nov, 2018, 9:29 AM  
Subject: Welcome to the AI for Earth Community  
To: richard.joseph@ves.ac.in <richard.joseph@ves.ac.in>  
Cc: AI for Earth Grants <AI4EGrants@microsoft.com>

Dear Richard,

**Congratulations, and welcome to the AI for Earth community!** We are excited to share that your application has been selected for an AI for Earth Microsoft Azure Compute Grant. Through this award, you will receive a sponsored Microsoft Azure account. We are granting you credits for Azure consumption up to **\$15,000 USD**, to be utilized within one year. Please note:

- The award will expire when you reach this level of cumulative usage or you reach the expiration date, **whichever occurs first**. Your expiration date will be confirmed upon activation.
- You will receive monthly statements letting you know the dollar amount of Azure that has been consumed and the dollar balance remaining; you can check usage anytime by logging into the [Azure portal](#).
- To track project progress, we require that you:
  - Answer quarterly surveys on progress
  - Submit a final report on results

### Next Steps:

- **Please complete this [Welcome Form](#) by November 12, 2018** - This is very important!
- After you attend the **mandatory Grantee Onboarding Webinar** (outlined in the Welcome Survey above), you will receive an email from [azdesk@microsoft.com](mailto:azdesk@microsoft.com) with more details and instructions on how to activate your account.
- Share any plans you may have around amplifying your AI4E award (including media outreach, press release, social media, etc.) with Michelle Lancaster, [milanca@microsoft.com](mailto:milanca@microsoft.com)

Congratulations again, and we are very happy to support your work in advancing environmental sustainability!

Best,

Bonnie Lei

AI for Earth Project Manager +1 4257068003 x68003

Environmental Sustainability [bonnie.lei@microsoft.com](mailto:bonnie.lei@microsoft.com)

cid:image002.jpg@01D4766D.FCD81740

**If you are nonprofit, academic, or start-up institution interested in accessing Esri software licenses, please follow the below instructions:**



# Vivekanand Education Society's Institute of Technology

(Affiliated to University of Mumbai, Approved by AICTE & Recognized by Govt. of Maharashtra)

Esri software licenses for ArcGIS Pro and ArcGIS Enterprise can be provided for the one year term of the grant.  
Please note:

- Award details will be determined by working with each grantee directly
- Your licenses will expire in one year
- Your use of the software is subject to the standard software licenses for the products.

Next steps:

- Please contact the appropriate representative to obtain access to the Esri Licensing award:
  - Educational Institutions please contact Ann Masangcay [amasangcay@esri.com](mailto:amasangcay@esri.com)
  - Nonprofit Organizations please contact Steve Beckwith [SBeckwith@esri.com](mailto:SBeckwith@esri.com)
  - Start-up Institutions please contact [startups@esri.com](mailto:startups@esri.com)
- If you already have access to Esri technology through an existing agreement, Esri will facilitate license distribution from the Educational Site License or Nonprofit Enterprise Agreement administrator.
- If you need access to Esri licenses, complimentary term licenses for ArcGIS Professional and ArcGIS Enterprise will be provided by the Esri support contacts listed above.

---

### 3 attachments

 Microsoft [image002.jpg](#)  
2K

 [3 Page AI4Earth Proposal-Water Supply Management and Catchment Control in Drought Prone Regions of Rural India.pdf](#)  
190K

 [Detailed AI for Earth 2018 Proposal - Water Supply Management and Catchment Control in Drought Prone Regions of Rural India.pdf](#)  
341K



# Vivekanand Education Society's Institute of Technology

(Affiliated to University of Mumbai, Approved by AICTE & Recognized by Govt. of Maharashtra)



Kajal Jewani <kajal.jewani@ves.ac.in>

## Welcome to the AI for Earth Community

Kajal Jewani <kajal.jewani@ves.ac.in>  
To: Lifna C S <lifna.cs@ves.ac.in>

Mon, Mar 18, 2019 at 11:41 AM

----- Forwarded message -----

From: **Kajal Jewani** <kajal.jewani@ves.ac.in>  
Date: Mon, Mar 18, 2019 at 9:30 AM  
Subject: Fwd: Welcome to the AI for Earth Community  
To: Lifna C S <lifna.cs@ves.ac.in>

----- Forwarded message -----

From: **AI for Earth Grants** <AI4EGrants@microsoft.com>  
Date: Thu, Nov 8, 2018, 9:24 AM  
Subject: Welcome to the AI for Earth Community  
To: kajal.jewani@ves.ac.in <kajal.jewani@ves.ac.in>  
Cc: AI for Earth Grants <AI4EGrants@microsoft.com>

Dear Kajal,

**Congratulations, and welcome to the AI for Earth community!** We are excited to share that your application has been selected for an AI for Earth Microsoft Azure Compute Grant. Through this award, you will receive a sponsored Microsoft Azure account. We are granting you credits for Azure consumption up to **\$15,000 USD**, to be utilized within one year. Please note:

- The award will expire when you reach this level of cumulative usage or you reach the expiration date, **whichever occurs first**. Your expiration date will be confirmed upon activation.
- You will receive monthly statements letting you know the dollar amount of Azure that has been consumed and the dollar balance remaining; you can check usage anytime by logging into the [Azure portal](#).
- To track project progress, we require that you:
  - Answer quarterly surveys on progress
  - Submit a final report on results

### Next Steps:

- **Please complete this Welcome Form by November 12, 2018** - This is very important!
- After you attend the **mandatory Grantee Onboarding Webinar** (outlined in the Welcome Survey above), you will receive an email from [azdesk@microsoft.com](mailto:azdesk@microsoft.com) with more details and instructions on how to activate your account.
- Share any plans you may have around amplifying your AI4E award (including media outreach, press release, social media, etc.) with Michelle Lancaster, [milanca@microsoft.com](mailto:milanca@microsoft.com)

Congratulations again, and we are very happy to support your work in advancing environmental sustainability!

Best,

Bonnie Lei



# Vivekanand Education Society's Institute of Technology

(Affiliated to University of Mumbai, Approved by AICTE & Recognized by Govt. of Maharashtra)

AI for Earth Project Manager +1 4257068003 x68003

Environmental Sustainability bonnie.lei@microsoft.com

cid:image002.jpg@01D4766D.FCD81740

***If you are nonprofit, academic, or start-up institution interested in accessing Esri software licenses, please follow the below instructions:***

*Esri software licenses for ArcGIS Pro and ArcGIS Enterprise can be provided for the one year term of the grant. Please note:*

- *Award details will be determined by working with each grantee directly*
- *Your licenses will expire in one year*
- *Your use of the software is subject to the standard software licenses for the products.*

*Next steps:*

- *Please contact the appropriate representative to obtain access to the Esri Licensing award:*
  - *Educational Institutions please contact Ann Masangcay [amasangcay@esri.com](mailto:amasangcay@esri.com)*
  - *Nonprofit Organizations please contact Steve Beckwitt [SBeckwitt@esri.com](mailto:SBeckwitt@esri.com)*
  - *Start-up Institutions please contact [startups@esri.com](mailto:startups@esri.com)*
- *If you already have access to Esri technology through an existing agreement, Esri will facilitate license distribution from the Educational Site License or Nonprofit Enterprise Agreement administrator.*
- *If you need access to Esri licenses, complimentary term licenses for ArcGIS Professional and ArcGIS Enterprise will be provided by the Esri support contacts listed above.*

—  
Thanks  
Ms.Kajal Jewani,  
Asst Prof.  
VESIT,Chembur,Mumbai

---

## 2 attachments

 Microsoft image002.jpg  
2K

 Microsoft image002.jpg  
2K





# Vivekanand Education Society's Institute of Technology

(Affiliated to University of Mumbai, Approved by AICTE & Recognized by Govt. of Maharashtra)



Sunita Sahu <sunita.sahu@ves.ac.in>

## Fwd: Welcome to the AI for Earth Community

3 messages

SAGAR MADNANI <2015sagar.madnani@ves.ac.in>  
To: Sunita Sahu <sunita.sahu@ves.ac.in>

Thu, Nov 8, 2018 at 12:40 PM

----- Forwarded message -----

From: AI for Earth Grants <AI4EGrants@microsoft.com>  
Date: Thu, 8 Nov 2018, 12:13 pm  
Subject: Welcome to the AI for Earth Community  
To: 2015sagar.madnani@ves.ac.in <2015sagar.madnani@ves.ac.in>  
Cc: AI for Earth Grants <AI4EGrants@microsoft.com>

Dear Sagar,

**Congratulations, and welcome to the AI for Earth community!** We are excited to share that your application has been selected for an AI for Earth Microsoft Azure Compute Grant. Through this award, you will receive a sponsored Microsoft Azure account. We are granting you credits for Azure consumption up to **\$5,000 USD**, to be utilized within one year. Please note:

- The award will expire when you reach this level of cumulative usage or you reach the expiration date, **whichever occurs first**. Your expiration date will be confirmed upon activation.
- You will receive monthly statements letting you know the dollar amount of Azure that has been consumed and the dollar balance remaining; you can check usage anytime by logging into the [Azure portal](#).
- To track project progress, we require that you:
  - Answer quarterly surveys on progress
  - Submit a final report on results

### Next Steps:

- **Please complete this [Welcome Form](#) by November 12, 2018** - This is very important!
- After you attend the **mandatory Grantee Onboarding Webinar** (outlined in the Welcome Survey above), you will receive an email from [azdesk@microsoft.com](mailto:azdesk@microsoft.com) with more details and instructions on how to activate your account.
- Share any plans you may have around amplifying your AI4E award (including media outreach, press release, social media, etc.) with Michelle Lancaster, [milanca@microsoft.com](mailto:milanca@microsoft.com)

Congratulations again, and we are very happy to support your work in advancing environmental sustainability!

Best,

Bonnie Lal

AI for Earth Project Manager +1 4257068003 x68003

Environmental Sustainability [bonnie.lal@microsoft.com](mailto:bonnie.lal@microsoft.com)

id:image002.jpg@01D4766D.FCD81740

**If you are nonprofit, academic, or start-up institution interested in accessing Esri software licenses, please follow the below instructions:**

*Esri software licenses for ArcGIS Pro and ArcGIS Enterprise can be provided for the one year term of the grant. Please note:*

- Award details will be determined by working with each grantee directly
- Your licenses will expire in one year
- Your use of the software is subject to the standard software licenses for the products.



# Vivekanand Education Society's Institute of Technology

(Affiliated to University of Mumbai, Approved by AICTE & Recognized by Govt. of Maharashtra)

University of Mumbai



Research Project No:187

NAME OF THE RESEARCHER : Indu Dokare  
LECTURE IN : Electronics Engg.  
AMOUNT SANCTIONED : Rs.25000 /-

Ref No. APD/237/601of 2019  
27th March, 2019

To,  
The Principal,  
Vivekanand Education Society's Institute of Technology  
Hashu Advani Memorial Complex  
VES Campus II, Chembur - 400074

Sub: - Minor Research Grant Project.

Sir/Madam,

I am directed to inform you that the said proposal has been considered by the University and the research grant as quoted above is sanctioned to the researcher.

The sanctioned amount will be disbursed in two installments. The first installment of 40% of the sanctioned amount will be disbursed within the month of March. The remaining 60% amount will be disbursed up to 31st August, 2019.

The researcher is expected to spend 60% amount initially from his/her own resources to carry out the work.

Further, I am to inform you that the researcher will have to utilize the 40% sanctioned amount on or before 31st March, 2019 and submit original bills/vouchers of the expenditure alongwith Utilization Certificate duly certified by the Principal/ Director/ Head/Institute/University Department of the College to the Accounts Section of University.

Please note that 60% balance amount out of sanctioned grant will be released after presentation of your proposal & final approval of the committee. You need to submit utilization certificate after presentation of your research and final approval of 60% grant including bills/vouchers/receipts in original through University Accounts Section.

The report of the research work carried out by the concerned researcher will have to be submitted to the University on or before 31st August 2019.

The Principal/Head of the Institute are requested to inform the researcher accordingly and arrange to forward his/her undertaking immediately to enable this office to release first installment of the research grant.

Yours faithfully,



# Vivekanand Education Society's Institute of Technology

(Affiliated to University of Mumbai, Approved by AICTE & Recognized by Govt. of Maharashtra)

University of Mumbai



Research Project No:105

NAME OF THE RESEARCHER : Rupali Hande  
LECTURE IN : Computer Engg.  
AMOUNT SANCTIONED : Rs.40000 /-

Ref No. APD/237/601 of 2019  
27th March, 2019

To,  
The Principal,  
Vivekanand Education Society's  
Institute of Technology, Hashu Advani Memorial Complex,  
Collector's Colony, Chembur, Mumbai - 400 074.

Sub: - Minor Research Grant Project.

Sir/Madam,

I am directed to inform you that the said proposal has been considered by the University and the research grant as quoted above is sanctioned to the researcher.

The sanctioned amount will be disbursed in two installments. The first installment of 40% of the sanctioned amount will be disbursed within the month of March. The remaining 60% amount will be disbursed up to 31st August, 2019.

The researcher is expected to spend 60% amount initially from his/her own resources to carry out the work.

Further, I am to inform you that the researcher will have to utilize the 40% sanctioned amount on or before 31st March, 2019 and submit original bills/vouchers of the expenditure alongwith Utilization Certificate duly certified by the Principal/ Director/ Head/Institute/University Department of the College to the Accounts Section of University.

Please note that 60% balance amount out of sanctioned grant will be released after presentation of your proposal & final approval of the committee. You need to submit utilization certificate after presentation of your research and final approval of 60% grant including bills/vouchers/receipts in original through University Accounts Section.

The report of the research work carried out by the concerned researcher will have to be submitted to the University on or before 31st August 2019.

The Principal/Head of the Institute are requested to inform the researcher accordingly and arrange to forward his/her undertaking immediately to enable this office to release first installment of the research grant.

Yours faithfully,

*Susawant*  
Assistant Registrar

(Academic Planning & Development)

University of Mumbai



Academic Planning &  
Development Section

NG/APD/ICD/2018-19/593  
16<sup>th</sup> March, 2019

Sub : Minor Research Grant Project 2018-19

Sir/Madam,

I am directed to inform you that the said proposal has been considered by the University and the research grant as quoted above is sanctioned to the researcher.

The sanctioned amount will be disbursed in two installments. The first installment of 40% of the sanctioned amount will be disbursed within the month of March. The remaining 60% amount will be disbursed up to 31<sup>st</sup> August, 2019.

The researcher is expected to spend 60% amount initially from his/her own resources to carry out the work.

Further, I am to inform you that the researcher will have to utilize the 40% sanctioned amount on or before 31<sup>st</sup> March, 2019 and submit original bills/vouchers of the expenditure along with Utilization Certificate duly certified by the Principal/Director/Head/Institute/University Department/College to the Accounts Section of the University.

Please note that 60% balance amount, out of sanctioned grant will be released after Poster Presentation & final approval of the committee. Therefore you need to submit of utilization certificate after presentation of your research including bills/vouchers/receipts in original through University Account Section.

The report of the research work carried out by the concerned researcher will have to be submitted to the University on or before 31<sup>st</sup> August, 2019.

**The Principal/Head of the Institute are requested to inform the researcher accordingly and arrange to forward his/her undertaking immediately to enable this office to release first installment of the research grant.**

Yours faithfully,

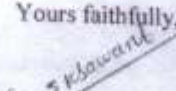
  
(Sanjana Sawant)  
Assistant Registrar  
(APD Section)





# Vivekanand Education Society's Institute of Technology

(Affiliated to University of Mumbai, Approved by AICTE & Recognized by Govt. of Maharashtra)

91	Vincy Joseph	St. Francis Institute of Tech. (Engg. College).	25000	
92	Mr. Anand Khandare	Thakur college of engineering and technology	25000	
93	Dr. Sheetal Rathi	Thakur college of Engineering and Technology, Mumbai	25000	
94	Ms. Sunita Suresh Suralkar	VES Institute of Technology Hashu advani Memorial Complex VES Campus II, Chembur - 400074	30000	
95	Rohini Temkar	Vivekanand College	30000	
96	Mrs. Shubhangi R. Patil	A. C. Patil College of Engineering	30000	
97	Shiwani Gupta	CMPN, TCET	35000	
98	Mr. Mushtak Yusuf Gadkari	Department of Computer Engineering, Rajendra Mane College of Engineering & Technology, Ambav(Devrukh)	30000	
99	Lakshmi Kurup	Dwarkadas J. Sanghvi College of Engineering, Vile Parle(W)	30000	
100	Mrs. Ashwini Amit Pansare	FR. Conceicao Rodrigues College Of Engineering	25000	
101	Varunakshi Bhojane	Pillai College of Engineering	40000	
102	Smita Vinit Bhoir	Ramrao Adik Institute of Technology	30000	
103	Dr. Rizwana Shaikh	SIES Graduate School of Technology	40000	
104	Dr. Kavita Sonawane	St. Fracis Institute of Technology	30000	
105	Rupali Hande	VES Institute of Technology	40000	
106	Anjali Yeole	Vivekanand Education Society's Institute of Technology	30000	
107	Dr. M. V. Bagal	Bharati Vidyapeeth's Institute of Management and Information Technology Sector - 8, CBD Belapur, Navi Mumbai	50000	Chemical Engg.
108	Nitin Gajanan Kanse	Finolex Academy of Management and Technology P-60, P-60/1, MIDC, Mirjole Block, Ratnagiri - 415 639	25000	
109	Dr. Sandip Hasuram Gharat	GHARDA INSTITUTE OF TECHNOLOGY A/P Lavel, Tal. Khed, Dist. Ratnagiri - 415 708	35000	
110	Dr. Sunita Pachori	Thakur College of Engineering and Technology Shyamnarayan Thakur Marg, Thakur Village, Kandivali (E) Mumbai	30000	



# Vivekanand Education Society's Institute of Technology

(Affiliated to University of Mumbai, Approved by AICTE & Recognized by Govt. of Maharashtra)



Since 1962

**Dr. (Mrs.) J. M. Nair**

M.Tech., Ph.D. (IT-IT)

Principal

Ref. No.: VESIT/JMN/RH/3458/2018-19

Date: 4/04/19

## Vivekanand Education Society's Institute of Technology

(Affiliated to University of Mumbai, Approved by AICTE & Recognised by Govt. of Maharashtra)

### Utilization Certificate

Certified that the sanctioned grant of Rs. **40,000/- (Forty Thousand only)** from the University Of Mumbai, under the scheme of support for Minor Grant Project entitled "**transparent and trackable donations using blockchain**" by Ms. Rupali Sambhaji Hande. **INR 14,297/- (Fourteen Thousand Two Hundred and Ninety Seven only)** has been utilized for the purpose and the bills have been submitted to the University accounts section for which it has been sanctioned and in accordance with the terms and conditions laid down by the university.

Research Project No: 105

University letter No: APD/237/601 of 2019

Mobile No: 7738880843

Dated: 27th March 2019

Ms. Rupali Sambhaji Hande  
Principal Investigator



Dr. Mrs. J.M. Nair  
Principal

**PRINCIPAL,**  
VIVEKANAND EDUCATION SOCIETY'S  
INSTITUTE OF TECHNOLOGY  
HASHU ADVANI MEMORIAL COMPLEX,  
COLLECTOR'S COLONY, CHEMBUR,  
MUMBAI-400 074, INDIA.



# Vivekanand Education Society's Institute of Technology

(Affiliated to University of Mumbai, Approved by AICTE & Recognized by Govt. of Maharashtra)

## Minor Research Project – Transparent and trackable donations using Block Chain

Sr. No.	Bill No.	Date of Bill	Particulars / Purpose	Amount (Rs.)	Indent No. & Sr. No.
1	Amazon.in Order ID. 402-941952 6-5825155	27/03/2019	Introducing Ethereum and Solidity: Foundation of Cryptocurrency and Blockchain programming for beginners chris Dannen Paperback Sold by: Knowledge Partners	559/-	CMPN/C457
			Blockchain Revolution: How the technology behind bitcoin and other cryptocurrencies is changing the world Tapscott, Don, Tapscott, Alex Paperback Sold by: amazing_buy fulfilled by amazon	359/-	CMPN/C456
			Hands-On Blockchain with hyperledger: building decentralized application with hyperledger fabric and composer Gaur, Nitin, DESrosiers, Luc, Ramkrishna, Venkatraman, Novotny, petr, Baset, Salman, O'Dowd, Antony Paperback Sold by: Repro books-on-demand Fulfilled by Amazon	1077/-	CMPN/C458
			<b>Order Total</b>	<b>1436/-</b>	
2	Udemy AD-666D476B 5958616B6D6 17839	26/03/2019	Ethereum and solidity: The Complete Developer's Guide	770/-	
			Blockchain Technology- The Complete course for Beginners	770/-	
			Learn Blockchain by building your own In JavaScript	770/-	



  
**PRINCIPAL,**  
**VIVEKANAND EDUCATION SOCIETY'S**  
**INSTITUTE OF TECHNOLOGY**  
**HASHLI ADVANI MEMORIAL COMPLEX,**  
**COLLECTOR'S COLONY, CHEMBUR,**  
**MUMBAI-400 074, INDIA.**



# Vivekanand Education Society's Institute of Technology

(Affiliated to University of Mumbai, Approved by AICTE & Recognized by Govt. of Maharashtra)

	Coursera Order no.:23873551	28/03/2019	Course certificate for Blockchain: Foundation and Use Cases	5667/-	
			<b>Order Total</b>	<b>7977/-</b>	
	Dhiraj Xerox Invoice No. 915	28/03/2018	Miscellaneous amount for Bill NO. 915	990/-	
	Microsoft Corporation (India) Private Limited:TIO19 HR100321286	27/03/2019	Microsoft Power BI	3894/-	

**Total Amount:1436+7977+990+3894=14297/-**



*[Signature]*  
PRINCIPAL,  
VIVEKANAND EDUCATION SOCIETY'S  
INSTITUTE OF TECHNOLOGY  
NARSHU ADVANI MEMORIAL COMPLEX,  
COLLECTOR'S COLONY, CHEMBUR,  
MUMBAI-400 074, INDIA.





# Vivekanand Education Society's Institute of Technology

Since 1962

(Affiliated to University of Mumbai, Approved by AICTE & Recognized by Govt. of Maharashtra)

VESIT/CMPN/2018-19/00311



Tax Invoice/Bill of Supply/Cash Memo  
(Original for Recipient)

**Sold By :**  
Repro Knowledgecast Ltd  
\* Renaissance Industrial Smart City, Block WA-V  
-1,2,3, Kalyan Padgha State Highway 222, Village  
Vashere, Post Aamne  
Thane, Maharashtra, 421302  
IN

**Billing Address :**  
Rupali Hande  
Vivekanand Education Societys Institute of  
Technology, Hashu Advani Memorial Complex  
Collectors Colony Chembur  
MUMBAI, MAHARASHTRA, 400074  
IN

PAN No: AAECR4557N  
GST Registration No: 27AAECR4557N3ZQ

**Shipping Address :**  
Rupali Hande  
Rupali Hande  
Vivekanand Education Societys Institute of  
Technology, Hashu Advani Memorial Complex  
Collectors Colony Chembur  
MUMBAI, MAHARASHTRA, 400074  
IN

Order Number: 402-6216412-4178701  
Order Date: 27.03.2019

Invoice Number : XWAB-274059  
Invoice Details : MH-XWAB-176059511-1819  
Invoice Date : 27.03.2019

Sl. No	Description	Unit Price	Discount	Qty	Net Amount	Tax Rate	Tax Type	Tax Amount	Total Amount
1	Hands-On Blockchain with Hyperledger: Building decentralized applications with Hyperledger Fabric and Composer   1788994523 ( RKC0003325124 )	₹1,077.00	₹0.00	1	₹1,077.00	0%	IGST	₹0.00	₹1,077.00
						0%	CGST	₹0.00	
						0%	IGST	₹0.00	
						0%	None	₹0.00	
						0%	VAT	₹0.00	
						0%	SGST	₹0.00	
	Shipping Charges	₹20.00	-₹20.00		₹0.00	0%	IGST	₹0.00	₹0.00
						0%	CGST	₹0.00	
						0%	IGST	₹0.00	
						0%	None	₹0.00	
						0%	VAT	₹0.00	
						0%	SGST	₹0.00	
<b>TOTAL:</b>								₹0.00	₹1,077.00

TOTAL: ₹0.00 ₹1,077.00

Amount in Words:  
One Thousand And Seventy-seven only

For Repro Knowledgecast Ltd:

Authorized Signatory



*Rupali Hande*  
PRINCIPAL,  
VIVEKANAND EDUCATION SOCIETY'S  
INSTITUTE OF TECHNOLOGY  
HASHU ADVANI MEMORIAL COMPLEX,  
COLLECTOR'S COLONY, CHEMBUR,  
MUMBAI-400 074, INDIA.



# Vivekanand Education Society's Institute of Technology

Since 1962

(Affiliated to University of Mumbai, Approved by AICTE & Recognized by Govt. of Maharashtra)



## Tax Invoice/Bill of Supply/Cash Memo (Original for Recipient)

**Sold By :**  
India Book Distributors (Bombay) Limited  
\* DTDC 3PL & Fulfillment Ltd NO.2-96/1 KVR  
Warehousing, Survey No.52 A & B Kandlakoi (V)  
Medchal (M), Medchal -MALKAJGIRI (D)  
Hyderabad, Telangana, 501401  
IN

**Billing Address :**  
Rupali Hande  
Vivekanand Education Societys Institute of  
Technology, Hashu Advani Memorial Complex  
Collectors Colony Chembur  
MUMBAI, MAHARASHTRA, 400074  
IN

**PAN No:** AAAC11048K  
**GST Registration No:** NotApplicable

**Shipping Address :**  
Rupali Hande  
Rupali Hande  
Vivekanand Education Societys Institute of  
Technology, Hashu Advani Memorial Complex  
Collectors Colony Chembur  
MUMBAI, MAHARASHTRA, 400074  
IN

**Order Number:** 402-6216412-4178701  
**Order Date:** 27.03.2019

**Invoice Number :** QSLJ-116299  
**Invoice Details :** TG-QSLJ-11971715-1819  
**Invoice Date :** 27.03.2019

Sl. No	Description	Unit Price	Discount	Qty	Net Amount	Tax Rate	Tax Type	Tax Amount	Total Amount
1	Blockchain Revolution: How the Technology Behind Bitcoin and Other Cryptocurrencies is Changing the World   0241237866 ( ABK 0315947 )	₹359.00	₹0.00	1	₹359.00	0%	IGST	₹0.00	₹359.00
						0%	CGST	₹0.00	
						0%	IGST	₹0.00	
						0%	None	₹0.00	
	Shipping Charges	₹20.00	-₹20.00		₹0.00	0%	IGST	₹0.00	₹0.00
						0%	CGST	₹0.00	
						0%	IGST	₹0.00	
						0%	None	₹0.00	
<b>TOTAL:</b>								₹0.00	₹359.00

**Amount in Words:**  
Three Hundred And Fifty-nine only

For India Book Distributors (Bombay) Limited:

Authorized Signatory



**PRINCIPAL,**  
VIVEKANAND EDUCATION SOCIETY'S  
INSTITUTE OF TECHNOLOGY  
HASHU ADVANI MEMORIAL COMPLEX,  
COLLECTOR'S COLONY, CHEMBUR,  
MUMBAI-400 074, INDIA.

\*GSTIN: Amazon India Services Pvt. Ltd., AARU-Amazon India Services Pvt. Ltd. Service Provider Place: India PIN: 560075 (Karnataka, India)  
(Difference between ending with GSTIN and the amount to be paid to the business account and purchase on Amazon India Services Pvt. Ltd. account is subject to audit)

Please note that this invoice is valid only for recipient.



# Vivekanand Education Society's Institute of Technology

Since 1962

(Affiliated to University of Mumbai, Approved by AICTE & Recognized by Govt. of Maharashtra)



**Tax Invoice/Bill of Supply/Cash Memo**  
(Triplicate for Supplier)

**Sold By :**  
Knowledge Partners  
\* co Mehul Book Sales, 10 and 11, First Floor,  
Kitab Mahal Bldg, 193, DN Road, Fort,  
Mumbai, MAHARASHTRA, 400001  
IN

**Billing Address :**  
Rupali Hande  
Vivekanand Education Societys Institute of  
Technology, Hashu Advani Memorial Complex  
Collectors Colony Chembur  
MUMBAI, MAHARASHTRA, 400074  
IN

**PAN No:** AOWPP2619A  
**GST Registration No:** NotApplicable

**Shipping Address :**  
Rupali Hande  
Rupali Hande  
Vivekanand Education Societys Institute of  
Technology, Hashu Advani Memorial Complex  
Collectors Colony Chembur  
MUMBAI, MAHARASHTRA, 400074  
IN

**Order Number:** 402-9419526-5825155  
**Order Date:** 27.03.2019

**Invoice Number :** IN-223  
**Invoice Details :** MH-138352001-1819  
**Invoice Date :** 28.03.2019

Sl. No	Description	Unit Price	Qty	Net Amount	Tax Rate	Tax Type	Tax Amount	Total Amount
1	Introducing Ethereum and Solidity: Foundations of Cryptocurrency and Blockchain Programming for Beginners   B07K2RRTL (9781484240120 )	₹500.00	1	₹500.00	0%	IGST	₹0.00	₹500.00
					0%	CGST	₹0.00	
					0%	IGST	₹0.00	
					0%	None	₹0.00	
					0%	VAT	₹0.00	
					0%	SGST	₹0.00	
	Shipping Charges	₹50.00		₹50.00	0%	IGST	₹0.00	₹50.00
					0%	CGST	₹0.00	
					0%	IGST	₹0.00	
					0%	None	₹0.00	
					0%	VAT	₹0.00	
					0%	SGST	₹0.00	

**TOTAL:** ₹0.00 ₹550.00

**Amount in Words:**  
Five Hundred And Fifty-nine only

**For Knowledge Partners:**

*Mehul Dhanraj*

**Authorized Signatory**



\*ASPL-Amazon India Services Pvt. Ltd. (Mumbai, Maharashtra, India) is the authorized signatory of the invoice. The invoice is generated by Amazon India Services Pvt. Ltd. (Mumbai, Maharashtra, India) on behalf of Amazon India Services Pvt. Ltd. (Mumbai, Maharashtra, India). The invoice is not a document for payment.

*Singh*  
**PRINCIPAL**  
**VIVEKANAND EDUCATION SOCIETY'S**  
**INSTITUTE OF TECHNOLOGY**  
HASHU ADVANI MEMORIAL COMPLEX,  
COLLECTOR'S COLONY, CHEMBUR,  
MUMBAI-400 074, INDIA.



# Vivekanand Education Society's Institute of Technology

Since 1962

(Affiliated to University of Mumbai, Approved by AICTE & Recognized by Govt. of Maharashtra)



Home / Purchase history / Receipt  
Receipt

## Receipt for Cart - April 3, 2019

Udemy

600 Harrison St. - 3rd Floor  
San Francisco, CA  
[udemy.com](http://udemy.com)

Date: March 26, 2019

Order #: AD-666D476B5958616B6D617839

Sold To: Rupali Soni

Item	Ordered	Coupon Code	Quantity	Price	Amount
Ethereum and Solidity: The Complete Developer's Guide	March 26, 2019	UDEAFFEI319	1	₹770	₹770
Blockchain Technology - The Complete Course for Beginners.	March 26, 2019	UDEAFFEI319	1	₹770	₹770
Learn Blockchain By Building Your Own In JavaScript	March 26, 2019	UDEAFFEI319	1	₹770	₹770
				Total	₹2,310
				Total	₹2,310
				Paid	

If you have any questions about this receipt please contact us at [support@udemy.com](mailto:support@udemy.com) (<mailto:support@udemy.com>)



*Rupali Soni*  
PRINCIPAL,  
VIVEKANAND EDUCATION SOCIETY'S  
INSTITUTE OF TECHNOLOGY  
HASHU ADVANI MEMORIAL COMPLEX,  
COLLECTOR'S COLONY, CHEMBUR,  
MUMBAI-400 074, INDIA.





# Vivekanand Education Society's Institute of Technology

Since 1962

(Affiliated to University of Mumbai, Approved by AICTE & Recognized by Govt. of Maharashtra)

VESIT/CMPN/2018-19/00313  
 CASH MEMO Mob.: 9029093128  
**Dhiraj Xerox**  
 Computer Printout,  
 Spiral Binding, Lamination, Stationery  
 Vesit Hamt Complex, Collectors Colony,  
 Chembur, Mumbai - 400 074.

No. 375 Date 29/3/19  
 M/s. Rupali hande

S/No.	Particulars	Rate	Amount	
			Rs.	P.
1	prints page & stationery & xerox		990	00
TOTAL			990	00

Goods once sold not be taken back.  
 E & O.E. Sign.



*Jyoti*  
 PRINCIPAL,  
 VIVEKANAND EDUCATION SOCIETY'S  
 INSTITUTE OF TECHNOLOGY  
 HASHU ADVANI MEMORIAL COMPLEX,  
 COLLECTOR'S COLONY, CHEMBUR,  
 MUMBAI-400 074, INDIA.



# Vivekanand Education Society's Institute of Technology

(Affiliated to University of Mumbai, Approved by AICTE & Recognized by Govt. of Maharashtra)

VESIT/CMPN/2018-19/00314



Rupali Hande <rupalihande1909@gmail.com>

## Your Receipt for Order #23873551

2 messages

Coursera <no-reply@l.mail.coursera.org>  
To: Rupali Hande <rupalihande1909@gmail.com>

Thu, Mar 28, 2019 at 1:58 PM



Dear Rupali Hande,

Thank you for your purchase.

### RECEIPT

Coursera Inc.  
381 E. Evelyn Avenue  
Mountain View, CA 94041 USA

03-28-2019  
Order Number: 23873551

Product Details	Price	Qty
Course Certificate for Blockchain: Foundations and Use Cases	INR 5667.00	1

**TOTAL (INR): 5667.00**

Please keep this receipt as record of your payment.

[View our refund policy.](#)

[View your purchase history.](#)

Happy Learning!  
The Coursera Team

Need help? [Contact Us.](#)



Visit support • Please do not reply directly to this email

Copyright (c) 2019 Coursera, Inc | 381 E. Evelyn Avenue, Mountain View, CA 94041, USA

*Jayalok*  
PRINCIPAL,  
VIVEKANAND EDUCATION SOCIETY'S  
INSTITUTE OF TECHNOLOGY  
HASHU ADVANI MEMORIAL COMPLEX,  
COLLECTOR'S CH. DWT, CHEMBUR,  
MUMBAI-400 074, INDIA.



# Vivekanand Education Society's Institute of Technology

(Affiliated to University of Mumbai, Approved by AICTE & Recognized by Govt. of Maharashtra)

University of Mumbai



Research Project No:94

NAME OF THE RESEARCHER : Ms. Sunita Suresh Suralkar  
LECTURE IN : Computer Engg.  
AMOUNT SANCTIONED : Rs.30000 /-

Ref No. APD/237/601 of 2019  
27th March, 2019

To,  
The Principal,  
VES Institute of Technology  
Hashu advani Memorial Complex  
VES Campus II, Chembur - 400074

Sub: - Minor Research Grant Project.

Sir/Madam,

I am directed to inform you that the said proposal has been considered by the University and the research grant as quoted above is sanctioned to the researcher.

The sanctioned amount will be disbursed in two installments. The first installment of 40% of the sanctioned amount will be disbursed within the month of March. The remaining 60% amount will be disbursed up to 31st August, 2019.

The researcher is expected to spend 60% amount initially from his/her own resources to carry out the work.

Further, I am to inform you that the researcher will have to utilize the 40% sanctioned amount on or before 31st March, 2019 and submit original bills/vouchers of the expenditure alongwith Utilization Certificate duly certified by the Principal/ Director/ Head/Institute/University Department of the College to the Accounts Section of University.

Please note that 60% balance amount out of sanctioned grant will be released after presentation of your proposal & final approval of the committee. You need to submit utilization certificate after presentation of your research and final approval of 60% grant including bills/vouchers/receipts in original through University Accounts Section.

The report of the research work carried out by the concerned researcher will have to be submitted to the University on or before 31st August 2019.

The Principal/Head of the Institute are requested to inform the researcher accordingly and arrange to forward his/her undertaking immediately to enable this office to release first installment of the research grant.

Yours faithfully,

  
Assistant Registrar  
(Academic Planning & Development)



# Vivekanand Education Society's Institute of Technology

(Affiliated to University of Mumbai, Approved by AICTE & Recognized by Govt. of Maharashtra)

University of Mumbai



Research Project No:106

NAME OF THE RESEARCHER : Anjali Yeole  
LECTURE IN : Computer Engg.  
AMOUNT SANCTIONED : Rs.30000 /-

Ref No. APD/237/601 of 2019  
27th March, 2019

To,  
The Principal,  
Vivekanand Education Society's  
Institute of Technology, Hashu Advani Memorial Complex,  
Collector's Colony, Chembur, Mumbai - 400 074.

Sub: - Minor Research Grant Project.

Sir/Madam,

I am directed to inform you that the said proposal has been considered by the University and the research grant as quoted above is sanctioned to the researcher.

The sanctioned amount will be disbursed in two installments. The first installment of 40% of the sanctioned amount will be disbursed within the month of March. The remaining 60% amount will be disbursed up to 31st August, 2019.

The researcher is expected to spend 60% amount initially from his/her own resources to carry out the work.

Further, I am to inform you that the researcher will have to utilize the 40% sanctioned amount on or before 31st March, 2019 and submit original bills/vouchers of the expenditure alongwith Utilization Certificate duly certified by the Principal/ Director/ Head/Institute/University Department of the College to the Accounts Section of University.

Please note that 60% balance amount out of sanctioned grant will be released after presentation of your proposal & final approval of the committee. You need to submit utilization certificate after presentation of your research and final approval of 60% grant including bills/vouchers/receipts in original through University Accounts Section.

The report of the research work carried out by the concerned researcher will have to be submitted to the University on or before 31st August 2019.

The Principal/Head of the Institute are requested to inform the researcher accordingly and arrange to forward his/her undertaking immediately to enable this office to release first installment of the research grant.

Yours faithfully,

*Siddhant*  
Assistant Registrar  
(Academic Planning & Development)





# Vivekanand Education Society's Institute of Technology

(Affiliated to University of Mumbai, Approved by AICTE & Recognized by Govt. of Maharashtra)

University of Mumbai



Research Project No:186

NAME OF THE RESEARCHER : Mrs. Nilma Vasant Warke  
LECTURE IN : Electronics Engg.  
AMOUNT SANCTIONED : Rs.20000/-

Ref No. APD/237/601 of 2019  
27th March, 2019

To,  
The Principal,  
Vivekanand Education Society's Institute of Technology  
Hashu Advani Memorial Complex  
VES Campus II, Chembur - 400074

Sub: - Minor Research Grant Project.

Sir/Madam,

I am directed to inform you that the said proposal has been considered by the University and the research grant as quoted above is sanctioned to the researcher.

The sanctioned amount will be disbursed in two installments. The first installment of 40% of the sanctioned amount will be disbursed within the month of March. The remaining 60% amount will be disbursed up to 31st August, 2019.

The researcher is expected to spend 60% amount initially from his/her own resources to carry out the work.

Further, I am to inform you that the researcher will have to utilize the 40% sanctioned amount on or before 31st March, 2019 and submit original bills/vouchers of the expenditure alongwith Utilization Certificate duly certified by the Principal/ Director/ Head/Institute/University Department of the College to the Accounts Section of University.

Please note that 60% balance amount out of sanctioned grant will be released after presentation of your proposal & final approval of the committee. You need to submit utilization certificate after presentation of your research and final approval of 60% grant including bills/vouchers/receipts in original through University Accounts Section.

The report of the research work carried out by the concerned researcher will have to be submitted to the University on or before 31st August 2019.

The Principal/Head of the Institute are requested to inform the researcher accordingly and arrange to forward his/her undertaking immediately to enable this office to release first installment of the research grant.

Yours faithfully,

*S. S. S. S.*  
Assistant Registrar  
(Academic Planning & Development)

Scanned by CamScanner

## Design and construction of a computer controlled High Resolution Research Grade Validation System for Hardware Research

### Abstract:

Electronic hardware systems are often designed and constructed based on new concepts and methods during research work in field of electronics engineering. The performance of these hardware systems needs to be validated for the input-output relationship for which these systems are designed. Conventional methods for validation of hardware research involve use of DSO, high resolution DMM etc. for testing of input and output signals. Input signals are generated using conventional signal generator units. These methods of validation give limited accuracy of 8 to 10 bits and are also susceptible to manual measurement errors. Hence these validation methods are often questioned by expert research workers in this field. For testing the hardware with high resolution these input signals should also be generated with high accuracy and resolution with varying amplitude and frequency which is not possible by conventional signal generators available in laboratories. The output of research system also needs to be measured with high resolution (16 bits) and compared with the desired output for error analysis. Thus existing instruments and test systems are not adequate for validation of the performance of the new hardware which has been developed as a part of research work aiming at high resolution, high accuracy over wide bandwidth. Here I propose a new high resolution computer controlled validation system for hardware research validation. Here, input to the hardware research system will be generated with computer controlled signal generator which will generate the signals with 16 bit resolution over bandwidth of 0-10MHz and amplitude from 100microvolts to 10 Volts. The output of the hardware system in response to the inputs is digitized using a high resolution (16 bits) ADC. The data from ADC is transferred to PC using high speed data transfer.

The system will be useful for validation of the performance of all electronics system including biomedical system applications. Useful for students and research workers in academic institutes, research centers and industries

*Waste*  
Mrs. Nilima Waske.



# Vivekanand Education Society's Institute of Technology

(Affiliated to University of Mumbai, Approved by AICTE & Recognized by Govt. of Maharashtra)

University of Mumbai



Research Project No:189

NAME OF THE RESEARCHER : Mrs. Kanchan Vivek Chavan  
LECTURE IN : Instrumentation Engineering  
AMOUNT SANCTIONED : Rs.20000 /-

Ref No. APD/23/60101/ 2019  
27th March, 2019

To,  
The Principal,  
Vivekanand Education Society's Institute of Technology  
HAMC, Collector Colony, Chembur, Mumbai - 74

Sub: - Minor Research Grant Project.

Sir/Madam,

I am directed to inform you that the said proposal has been considered by the University and the research grant as quoted above is sanctioned to the researcher.

The sanctioned amount will be disbursed in two instalments. The first installment of 40% of the sanctioned amount will be disbursed within the month of March. The remaining 60% amount will be disbursed up to 31st August, 2019.

The researcher is expected to spend 60% amount initially from his/her own resources to carry out the work.

Further, I am to inform you that the researcher will have to utilize the 40% sanctioned amount on or before 31st March, 2019 and submit original bills/vouchers of the expenditure alongwith Utilization Certificate duly certified by the Principal/ Director/ Head/Institute/University Department of the College to the Accounts Section of University.

Please note that 60% balance amount out of sanctioned grant will be released after presentation of your proposal & final approval of the committee. You need to submit utilization certificate after presentation of your research and final approval of 60% grant including bills/vouchers/receipts in original through University Accounts Section.

The report of the research work carried out by the concerned researcher will have to be submitted to the University on or before 31st August 2019.

The Principal/Head of the Institute are requested to inform the researcher accordingly and arrange to forward his/her undertaking immediately to enable this office to release first installment of the research grant.

Yours faithfully,

*S. Resavant*  
Assistant Registrar  
(Academic Planning & Development)



## Time to Digital converter for Nuclear Timing Spectroscopy Systems

**Project Incharge:** Mrs. Kanchan Chavan

**Area of Research:** Nuclear Instrumentation

### Abstract/Description:

Time Interval measurement is required in various applications from different domains e.g. Laser ranging applications, the laser pulse is used to detect the distance of the object. Precise measurement is required of time interval when the laser beam is sent and the arrival of the reflected beam from the object. Time of flight measurement experiments are used in timing spectroscopy systems, lifetime measurements in atomic and high energy physics, nuclear medical instruments etc.

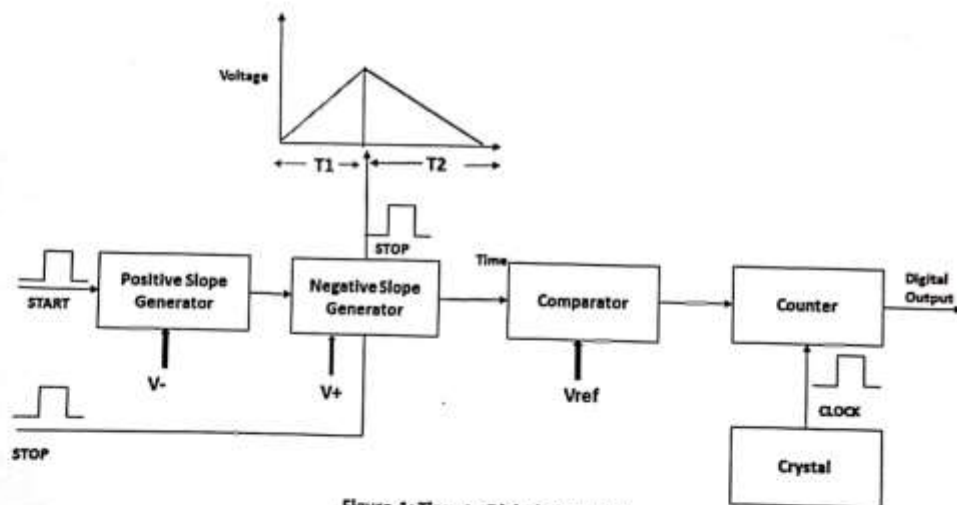

Figure 1: Time to Digital Converter

The main aim of the Project is to develop Time to Digital Converter (TDC). Refer Figure 1. At the arrival of START pulse, positive slope generator starts building ramp at the output using Reference Input 1 (negative voltage). During time interval T1- ramp starts increases in positive direction. Ramp slope and voltage magnitude is decided by the designed components of positive slope generator. When STOP pulse is received, Reference Input 2





# Vivekanand Education Society's Institute of Technology

(Affiliated to University of Mumbai, Approved by AICTE & Recognized by Govt. of Maharashtra)

(positive voltage - having opposite polarity w.r.t. Reference Input 1) is connected to negative slope generator. Ramp starts decreasing in the negative direction during time interval  $T_2$ . When ramp crosses zero (ground line), it is detected by Comparator. Time interval (when ramp is decreasing) is digitally counted by counter. So higher the input time difference between START and STOP pulse, ramp increases in positive direction to large magnitude of voltage, hence time required for decreasing ramp is more and so the digital counter output increases in proportion to this time interval.

Depending upon the range of the time interval measurement the positive slope generator circuit will generate calibrated slopes and accordingly negative slope generator circuit will also generate corresponding calibrated negative slopes. These slopes will be decided depending upon the range and resolution required for TDC.



# Vivekanand Education Society's Institute of Technology

(Affiliated to University of Mumbai, Approved by AICTE & Recognized by Govt. of Maharashtra)

University of Mumbai



Academic Planning &  
Development Section

No.APD/ICD/2018-19/593  
16<sup>th</sup> March, 2019

Sub : Minor Research Grant Project 2018-19

Sir/Madam,

I am directed to inform you that the said proposal has been considered by the University and the research grant as quoted above is sanctioned to the researcher.

The sanctioned amount will be disbursed in two installments. The first installment of 40% of the sanctioned amount will be disbursed within the month of March. The remaining 60% amount will be disbursed up to 31<sup>st</sup> August, 2019.

The researcher is expected to spend 60% amount initially from his/her own resources to carry out the work.

Further, I am to inform you that the researcher will have to utilize the 40% sanctioned amount on or before 31<sup>st</sup> March, 2019 and submit original bills/vouchers of the expenditure along with Utilization Certificate duly certified by the Principal/Director/Head/Institute/University Department/College to the Accounts Section of the University.

Please note that 60% balance amount, out of sanctioned grant will be released after Poster Presentation & final approval of the committee. Therefore you need to submit of utilization certificate after presentation of your research including bills/vouchers/receipts in original through University Account Section.

The report of the research work carried out by the concerned researcher will have to be submitted to the University on or before 31<sup>st</sup> August, 2019.

**The Principal/Head of the Institute are requested to inform the researcher accordingly and arrange to forward his/her undertaking immediately to enable this office to release first installment of the research grant.**

Yours faithfully,

*S. Sawant*  
(Sanjana Sawant)  
Assistant Registrar  
(APD Section)

Scanned by CamScanner



# Vivekanand Education Society's Institute of Technology

(Affiliated to University of Mumbai, Approved by AICTE & Recognized by Govt. of Maharashtra)

229	Dr. Madhuri Rao	Thadomal Shahani Engineering College	<b>35000</b>
230	DILIP MOTWANI	VIDYALANKAR INSTITUTE OF TECHNOLOGY	<b>15000</b>
231	Dr. (Mrs.) Shalu Chopra	Vivekanand Education Society's Institute Of Technology, Chembur	<b>15000</b>
232	Mr. Prasad Padalkar	Don Bosco Institute of Technology Premier Automobile Road, Kurla (W) -70	<b>30000</b>
233	Prof. Chhaya Narvekar	Xavier Institute of Engineering Mahim Causeway, Mahim, Mumbai - 400 016	<b>15000</b>
234	Mr. Shridhar Kamble	Thakur College of Engineering & Technology A- Block, Thakur Educational Campus, Shyamnarayan Thakur Marg, Thakur Village, Kandivali (E), Mumbai - 400 101	<b>25000</b>



# Vivekanand Education Society's Institute of Technology

(Affiliated to University of Mumbai, Approved by AICTE & Recognized by Govt. of Maharashtra)

189	Mrs. Kanchan Vivek Chavan	Vivekanand Education Society's Institute of Technology	20000	
190	Yogesh H. Patil	A. C. Patil College of Engineering	25000	
191	Popat Rajaram Bhosale	KONKAN GYANPEETH COLLEGE OF ENGG KARJAT	35000	
192	Poonam Rajendra Mogal (Waje)	Department of Instrumentation Engineering, Ramrao Adik Institute of Technology,	30000	
193	Ramakant Shripat Patil	Department of Instrumentation Engineering, Ramrao Adik Institute of Technology,	35000	
194	Mrs. Supriya Bhuran	Department of Instrumentation Engineering	25000	
195	Dr. Hari Vasudevan	Dwarkadas J. Sanghvi college of Engineering, Production Engineering Dept.	50000	Production Engineering
196	Anuradha Bharat Mistry	Thadomal Shahani Engineering College, Department of Biomedical Engineering	15000	Bio-Medical Engineering
197	Manali Godse	Dwarkadas J. Sanghvi College of Engineering	40000	
198	Prof. Nileema Pathak	Atharva College of Engineering	35000	Information Technology
199	Dr. Shanta Sondur " Professor	Department of Information technology, VES Institute of Technology Hashu Advani Memorial Complex VES Campus II, Chembur - 400074	35000	
200	Mrs Vaishali Kavathekar	Don Bosco Institute of Technology, Kurla West, Mumbai 400070.	15000	
201	Mrs. Sarika Manoj Davare	Fr. Conceicao Rodrigues C.O.E. Bandra/ Information Technology	25000	





# Vivekanand Education Society's Institute of Technology

(Affiliated to University of Mumbai, Approved by AICTE & Recognized by Govt. of Maharashtra)

210	Ms grinal Merwin Tuscano	St. Francis Institute of Technology	<b>35000</b>
211	Prajyoti D'silva	St. Francis Institute of Technology/Information Technology Department	<b>35000</b>
212	Brinzel Rodrigues	St. John College of Engineering and Management	<b>25000</b>
213	Shraddha More	St. John College of Engineering and Management	<b>15000</b>
214	Hetal Amrutia	Thakur College of Engineering and Technology/Information Technology	<b>40000</b>
215	Vidya chitre	Vidyalankar Institute of Technology , Information Technology	<b>20000</b>
216	SUKANYA ROYCHOWDHURY	Vivekanand Education Society's™ Institute of Technology, Department of Information Technology	<b>35000</b>
217	Dr. Kumudini Das	Pillai College of Arts, Commerce & Science(Information Technology) Dr. Vasudevan Pillais Campus, Plot No. 10, Sector 16, New Panvel, Maharashtra - 410 210	<b>31500</b>
218	Dr. Santosh Kumar Singh	Thakur College of Science and Commerce Shyamnarayan Thakur Marg, Thakur Village, Kandivali (E), Mumbai - 400 101	<b>50000</b>



# Vivekanand Education Society's Institute of Technology

(Affiliated to University of Mumbai, Approved by AICTE & Recognized by Govt. of Maharashtra)

University of Mumbai



Research Project No:216

NAME OF THE RESEARCHER  
LECTURE IN  
AMOUNT SANCTIONED

: SUKANYA ROYCHOWDHURY  
: Information Technology  
: Rs.35000 /-

Ref No. APD/237/601 of 2019  
27th March, 2019

To,  
The Principal,  
Vivekanand Education Society's Institute of Technology  
Hashu Advani Memorial Complex  
VES Campus II, Chembur - 400074

Sub: - Minor Research Grant Project.

Sir/Madam,

I am directed to inform you that the said proposal has been considered by the University and the research grant as quoted above is sanctioned to the researcher.

The sanctioned amount will be disbursed in two installments. The first installment of 40% of the sanctioned amount will be disbursed within the month of March. The remaining 60% amount will be disbursed up to 31st August, 2019.

The researcher is expected to spend 60% amount initially from his/her own resources to carry out the work.

Further, I am to inform you that the researcher will have to utilize the 40% sanctioned amount on or before 31st March, 2019 and submit original bills/vouchers of the expenditure alongwith Utilization Certificate duly certified by the Principal/ Director/ Head/Institute/University Department of the College to the Accounts Section of University.

Please note that 60% balance amount out of sanctioned grant will be released after presentation of your proposal & final approval of the committee. You need to submit utilization certificate after presentation of your research and final approval of 60% grant including bills/vouchers/receipts in original through University Accounts Section.

The report of the research work carried out by the concerned researcher will have to be submitted to the University on or before 31st August 2019.

The Principal/Head of the Institute are requested to inform the researcher accordingly and arrange to forward his/her undertaking immediately to enable this office to release first installment of the research grant.

Yours faithfully,

*S. U. Wani*

Assistant Registrar  
(Academic Planning & Development)

Scanned by CamScanner



# Vivekanand Education Society's Institute of Technology

Since 1962

(Affiliated to University of Mumbai, Approved by AICTE & Recognized by Govt. of Maharashtra)



Partners **Deloitte** **DEVNET** **KPIT** Communication Partners **S**



# Vivekanand Education Society's Institute of Technology

(Affiliated to University of Mumbai, Approved by AICTE & Recognized by Govt. of Maharashtra)

University of Mumbai



Academic Planning &  
Development Section

No.APD/ICD/2018-19/593  
16<sup>th</sup> March, 2019

Sub : Minor Research Grant Project 2018-19

Sir/Madam,

I am directed to inform you that the said proposal has been considered by the University and the research grant as quoted above is sanctioned to the researcher.

The sanctioned amount will be disbursed in two installments. The first installment of 40% of the sanctioned amount will be disbursed within the month of March. The remaining 60% amount will be disbursed up to 31<sup>st</sup> August, 2019.

The researcher is expected to spend 60% amount initially from his/her own resources to carry out the work.

Further, I am to inform you that the researcher will have to utilize the 40% sanctioned amount on or before 31<sup>st</sup> March, 2019 and submit original bills/vouchers of the expenditure along with Utilization Certificate duly certified by the Principal/Director/Head/Institute/University Department/College to the Accounts Section of the University.

Please note that 60% balance amount, out of sanctioned grant will be released after Poster Presentation & final approval of the committee. Therefore you need to submit of utilization certificate after presentation of your research including bills/vouchers/receipts in original through University Account Section.

The report of the research work carried out by the concerned researcher will have to be submitted to the University on or before 31<sup>st</sup> August, 2019.

The Principal/Head of the Institute are requested to inform the researcher accordingly and arrange to forward his/her undertaking immediately to enable this office to release first installment of the research grant.

Yours faithfully,

*S. Sawant*  
(Sanjana Sawant)  
Assistant Registrar  
(APD Section)





# Vivekanand Education Society's Institute of Technology

(Affiliated to University of Mumbai, Approved by AICTE & Recognized by Govt. of Maharashtra)

85	Ms. Sushopti D. Gawade	Pillai College of Engineering , Panvel	<b>25000</b>
86	Dr. Ashok Kanthe	Pillai HOC College Engineering & Technology	<b>30000</b>
87	Mrs. Swarupa Sandeep Bodhe	Ramrao Adik Institute of Technology	<b>30000</b>
88	Prof. Dr. Vidhate Amarsinh	Ramrao Adik Institute of Technology	<b>25000</b>
89	TUSHAR H GHORPADE	Ramrao Adik Institute of Technology	<b>25000</b>
90	Dr. Bhavesh Patel	Shah & Anchor Kutchhi Engineering College	<b>30000</b>

91	Vincy Joseph	St. Francis Institute of Tech. (Engg. College),	<b>25000</b>	
92	Mr. Anand Khandare	Thakur college of engineering and technology	<b>25000</b>	
93	Dr. Sheetal Rathi	Thakur college of Engineering and Technology, Mumbai	<b>25000</b>	
94	Ms. Sunita Suresh Suralkar	VES Institute of Technology Hashu advani Memorial Complex VES Campus II, Chembur - 400074	<b>30000</b>	
95	Rohini Temkar	Vivekanand College	<b>30000</b>	
96		ngi R. Patil A. C. Patil College of	<b>30000</b>	
97	Shiwani Gupta	CMPN, TCET	<b>35000</b>	
98	Mr. Mushtak Yusuf Gadkari	Department of Computer Engineering, Rajendra Mane College of Engineering & Technology, Ambav(Devrukh)	<b>30000</b>	
99	Lakshmi Kurup	Dwarkadas J. Sanghvi College of Engineering, Vile Parle(W)	<b>30000</b>	
100	Mrs. Ashwini Amit Pansare	FR. Conceicao Rodrigues College Of Engineering	<b>25000</b>	
101	Varunakshi Bhojane	Pillai College of Engineering	<b>40000</b>	



# Vivekanand Education Society's Institute of Technology

(Affiliated to University of Mumbai, Approved by AICTE & Recognized by Govt. of Maharashtra)

Ref AISECT/CRG/RP/2020/18

Core Research Group (CRG)  
Rabindranath Tagore University Campus,  
Village Mendua, Post Bhojpur,  
Dist. Raisen-464993 (M.P.)

**Dr. S. Veenadhari**  
**Ms. Meenakshi Mittal**  
RNTU Bhopal

## Approval of the Project for Internal Funding

We are pleased to inform you that the Research Project submitted by you with following details has been approved for internal funding by CRG:-

Research Project Details				
S. No.	Title of the Project	Name of PI	Cost in Rs.	Time Duration
1.	Search Engine Ranking Prediction & Improvement. Using Neural Networks	Dr. S. Veenadhari Ms. Meenakshi Mittal	0.70L	03 months

### Expected Deliverables

1. All deliverables committed in the project proposal submitted by the PI.
2. Minimum 2 research papers. One in Scopus/web of science/Springer or of similar status journal and one in UGC Approved Journal or in/Anusandhan/Shodhaytan.
3. Working Model and Patent where ever possible with credit to the University.
4. Project Report in 3 copies.

### Major Terms & Conditions

1. Fifty percent of cost of the project will be allotted through a cheque drawn in favour of the PI. The PI must provide SB Account details and a copy of Adhar Card and Pan Card.
2. For purchase of any item or payment for services the PI & team will strictly follow purchase policy of the AISECT.
3. The PI shall try to do bulk purchase of consumables and claim maximum discount Remaining purchases could be done on as required basis.
4. Equipment, tools and consumables will be brought on charge in the Central Stock Register.
5. PI will ensure that available manpower and eqpt resources available in the university are utilised for the project and no hiring done from outside.

You are requested to send written acceptance of terms and condition in the format enclosed.

-----SD-----  
**Prof. Vijay Kant Verma**  
Convener CRG  
Rabindranath Tagore University

### Copy to

1. VC RNTU Bhopal



# Vivekanand Education Society's Institute of Technology

(Affiliated to University of Mumbai, Approved by AICTE & Recognized by Govt. of Maharashtra)

 **VIVEKANAND EDUCATION SOCIETY'S**  
**INSTITUTE OF TECHNOLOGY**  
(Affiliated to University of Mumbai - Approved by AICTE & Recognized by Govt. of Maharashtra)

Dr. Mrs. J. M. Nair  
Principal  
Date: 28/3/2018  
Ref. No. : VESIT/DM/2780/2017-18

### UTILIZATION CERTIFICATE

Certified that the sanctioned grant of Rs. 25,000/- (Rupees Twenty five thousand only) from the University of Mumbai, under the scheme of support for Minor Research Project entitled "Mind Controlled Assistive Quadrotor Drone" by Mrs. Ashwini Sawant has been fully utilized for the purpose for which it has sanctioned and in accordance with the terms and conditions laid down by the University.

Proposal No: S-210

University Letter No:

  
Principal Investigator

C.P.I.

  
Principal

Date: .....

College Seal



Hashu Advani Memorial Complex, Collector's Colony, F. C. Marg, Chembur, Mumbai - 400 074  
Phone: (022) 61532532 Fax: (022) 61532555 email: vesit@vsnl.com website: www.vesit.edu



# Vivekanand Education Society's Institute of Technology

Since 1962

(Affiliated to University of Mumbai, Approved by AICTE & Recognized by Govt. of Maharashtra)



2

Research Project No: 418

NAME OF THE RESEARCHER  
LECTURE IN  
AMOUNT SANCTIONED

: Mrs. Nusrat Ansari  
: Electronics & Telecommunication  
: Rs. 26,500/-

Ref No. APD/237/323 of 2018  
27<sup>th</sup> March, 2018

To,  
The Principal,  
Vivekanand Education Societys Institute of Technology  
Hashu Advani Memorial Complex, Collector's Colony,  
R.C. Marg, Chembur, Mumbai-400 074.

Sub: - Minor Research Grant Project.

Sir/Madam,

I am directed to inform you that the said proposal has been considered by the University and the research grant as quoted above is sanctioned to the researcher.

The sanctioned amount will be disbursed in two installments. The first installment of 40% of the sanctioned amount will be disbursed within the month of March. The remaining 60% amount will be disbursed up to 31<sup>st</sup> August, 2018.

The researcher is expected to spend 60% amount initially from his/her own resources to carry out the work.

Further, I am to inform you that the researcher will have to utilize the 40% sanctioned amount on or before 31<sup>st</sup> March, 2018 and submit original bills/vouchers of the expenditure alongwith Utilization Certificate duly certified by the Principal/ Director/ Head/Institute/University Department of the College to the Accounts Section of University.

Please note that 60% balance amount out of sanctioned grant will be released after presentation of your proposal & final approval of the committee. You need to submit utilization certificate after presentation of your research and final approval of 60% grant including bills/vouchers/receipts in original through University Accounts Section.

The report of the research work carried out by the concerned researcher will have to be submitted to the University on or before 31<sup>st</sup> August 2018.

The Principal/Head of the Institute are requested to inform the researcher accordingly and arrange to forward his/her undertaking immediately to enable this office to release first installment of the research grant.

Yours faithfully  
*S. Subramani*  
Assisant Registrar  
(Academic Planning & Development)





# Vivekanand Education Society's Institute of Technology

Since 1962

(Affiliated to University of Mumbai, Approved by AICTE & Recognized by Govt. of Maharashtra)



Research Project No: 422

NAME OF THE RESEARCHER  
LECTURE IN  
AMOUNT SANCTIONED

: Ms. Anuradha Jadiya  
: Electronics & Telecommunication  
: Rs. 24,000/-

Ref No. APD/237/323 of 2018  
27<sup>th</sup> March, 2018

To,  
The Principal,  
Vivekanand Education Societys Institute of Technology  
Hashu Advani Memorial Complex,  
Collector's Colony,  
R.C. Marg, Chembur,  
Mumbai-400 074.

Sub: - Minor Research Grant Project.

Sir/Madam,

I am directed to inform you that the said proposal has been considered by the University and the research grant as quoted above is sanctioned to the researcher.

The sanctioned amount will be disbursed in two installments. The first installment of 40% of the sanctioned amount will be disbursed within the month of March. The remaining 60% amount will be disbursed up to 31<sup>st</sup> August, 2018.

The researcher is expected to spend 60% amount initially from his/her own resources to carry out the work.

Further, I am to inform you that the researcher will have to utilize the 40% sanctioned amount on or before 31<sup>st</sup> March, 2018 and submit original bills/vouchers of the expenditure alongwith Utilization Certificate duly certified by the Principal/ Director/ Head/Institute/University Department of the College to the Accounts Section of University.

Please note that 60% balance amount out of sanctioned grant will be released after presentation of your proposal & final approval of the committee. You need to submit utilization certificate after presentation of your research and final approval of 60% grant including bills/vouchers/receipts in original through University Accounts Section.

The report of the research work carried out by the concerned researcher will have to be submitted to the University on or before 31<sup>st</sup> August 2018.

Yours faithfully

*S. S. Sawant*  
Assistant Registrar

(Academic Planning & Development Section)



# Vivekanand Education Society's Institute of Technology

Since 1962

(Affiliated to University of Mumbai, Approved by AICTE & Recognized by Govt. of Maharashtra)

University of Mumbai



OK  
Approved  
19/3/18  
A. 20,520/

Research Project No: 344

NAME OF THE RESEARCHER : Mrs. Gresha S. Bhatia  
LECTURE IN : Computer Engineering  
AMOUNT SANCTIONED : Rs. 40000/-

Ref No. APD/237/323 of 2018  
27<sup>th</sup> March, 2018

To,  
The Principal,  
Vivekanand Education Society's Institute of Technology  
Hashu Advani Memorial Complex  
VES Campus II,  
Chembur-400 074.

Sub: - Minor Research Grant Project.

Sir/Madam,

I am directed to inform you that the said proposal has been considered by the University and the research grant as quoted above is sanctioned to the researcher.

The sanctioned amount will be disbursed in two installments. The first installment of 40% of the sanctioned amount will be disbursed within the month of March. The remaining 60% amount will be disbursed up to 31<sup>st</sup> August, 2018.

The researcher is expected to spend 60% amount initially from his/her own resources to carry out the work.

Further, I am to inform you that the researcher will have to utilize the 40% sanctioned amount on or before 31<sup>st</sup> March, 2018 and submit original bills/vouchers of the expenditure alongwith Utilization Certificate duly certified by the Principal/ Director/ Head/Institute/University Department of the College to the Accounts Section of University.

Please note that 60% balance amount out of sanctioned grant will be released after presentation of your proposal & final approval of the committee. You need to submit utilization certificate after presentation of your research and final approval of 60% grant including bills/vouchers/receipts in original through University Accounts Section.

The report of the research work carried out by the concerned researcher will have to be submitted to the University on or before 31<sup>st</sup> August 2018.

The Principal/Head of the Institute are requested to inform the researcher accordingly and arrange to forward his/her undertaking immediately to enable this office to release first installment of the research grant.

Yours faithfully,

*S. S. Sawarkar*  
Assistant Registrar

(Academic Planning Development)

Scanned by CamScanner

University of Mumbai



Research Project No: 326

NAME OF THE RESEARCHER : Mr. Richard Joseph  
LECTURE IN : Computer Engineering  
AMOUNT SANCTIONED : Rs. 40000/-

Ref No. APD/237/323of 2018  
27<sup>th</sup> March, 2018

To,  
The Principal,  
Vivekanand Education Society's Institute of Technology  
Hashu Advani Memorial Complex  
VES Campus II,  
Chembur-400 074.

Sub: - Minor Research Grant Project.

Sir/Madam,

I am directed to inform you that the said proposal has been considered by the University and the research grant as quoted above is sanctioned to the researcher.

The sanctioned amount will be disbursed in two installments. The first installment of 40% of the sanctioned amount will be disbursed within the month of March. The remaining 60% amount will be disbursed up to 31<sup>st</sup> August, 2018.

The researcher is expected to spend 60% amount initially from his/her own resources to carry out the work.

Further, I am to inform you that the researcher will have to utilize the 40% sanctioned amount on or before 31<sup>st</sup> March, 2018 and submit original bills/vouchers of the expenditure alongwith Utilization Certificate duly certified by the Principal/ Director/ Head/Institute/University Department of the College to the Accounts Section of University.

Please note that 60% balance amount out of sanctioned grant will be released after presentation of your proposal & final approval of the committee. You need to submit utilization certificate after presentation of your research and final approval of 60% grant including bills/vouchers/receipts in original through University Accounts Section.

The report of the research work carried out by the concerned researcher will have to be submitted to the University on or before 31<sup>st</sup> August 2018.

The Principal/Head of the Institute are requested to inform the researcher accordingly and arrange to forward his/her undertaking immediately to enable this office to release first installment of the research grant.

Yours faithfully  
*SK Sawant*  
Assisstant Registrar  
(Academic Planning Development)

Sanket Paratkar, Deepa Narayan, Nikhil Dalvi, Akash Birari have won the 1st prize in Smart India hackathon on 31st March 2018 at science and technology NCL Pune under the guidance of Prof. Manisha Gahirwal and Abha Tewari







# Vivekanand Education Society's Institute of Technology

(Affiliated to University of Mumbai, Approved by AICTE & Recognized by Govt. of Maharashtra)

RECEIVED	INWARD SECTION
	NO. 232
	19/04/2018

University of Mumbai



Research Project No: 401

NAME OF THE RESEARCHER : Amudha Senthilkumar  
LECTURE IN : Instrumentation Engineering  
AMOUNT SANCTIONED : Rs. 20,000/-

Ref No. APD [REDACTED]

To,  
The Principal,  
Vivekanand Education Society's Institute of Technology  
Hashu Advani Memorial  
Complex VES Campus II,  
Chembur-400 074.

Sub: - Minor Research Grant Project.

Sir/Madam,

I am directed to inform you that the said proposal has been considered by the University and the research grant as quoted above is sanctioned to the researcher.

The sanctioned amount will be disbursed in two installments. The first installment of 40% of the sanctioned amount will be disbursed within the month of March. The remaining 60% amount will be disbursed up to 31<sup>st</sup> August, 2018.

The researcher is expected to spend 60% amount initially from his/her own resources to carry out the work.

Further, I am to inform you that the researcher will have to utilize the 40% sanctioned amount on or before 31<sup>st</sup> March, 2018 and submit original bills/vouchers of the expenditure alongwith Utilization Certificate duly certified by the Principal/ Director/ Head/Institute/University Department of the College to the Accounts Section of University.

Please note that 60% balance amount out of sanctioned grant will be released after presentation of your proposal & final approval of the committee. You need to submit utilization certificate after presentation of your research and final approval of 60% grant including bills/vouchers/receipts in original through University Accounts Section.

The report of the research work carried out by the concerned researcher will have to be submitted to the University on or before 31<sup>st</sup> August 2018.

The Principal/Head of the Institute are requested to inform the researcher accordingly and arrange to forward his/her undertaking immediately to enable this office to release first installment of the research grant.

Yours faithfully

*S. J. J. J.*

Assistant Registrar  
(Academic Planning Development)



# Vivekanand Education Society's Institute of Technology

Since 1962

(Affiliated to University of Mumbai, Approved by AICTE & Recognized by Govt. of Maharashtra)

(6)

University of Mumbai

Research Project No: 501

NAME OF THE RESEARCHER: Mr. Rajesh Naik

LECTURE IN Electronics & Telecommunication

AMOUNT SANCTIONED: Rs. 50000

Ref No. APD/237/471 of 2017  
January, 2017

To,  
The Principal,  
Vivekanand Education Society's Institute of Technology,  
Deemed to be University,  
Chhatrapati Shivaji Maharaj Vastu Sangrahalaya,  
Mumbai - 400 032.

Sir/Madam,

With reference to the Research Proposal forwarded by you in respect of Shri/Smt/Kum Mr. Rajesh Naik, I am directed to inform you that the said proposal has been considered by the University and the Committee has recommended research grant as quoted above to the researcher.

The sanctioned amount will be disbursed in two instalments. The first instalment of 50% of the sanctioned amount will be disbursed within 15 days on receiving undertaking and RTGS Form (copy enclosed) from the researcher.

The researcher is expected to spend 50% amount initially from his/her own resources to carry out the work. **Please note that 50% balance amount, out of sanctioned grant will be released on the submission of utilization certificate including bills/vouchers/receipts in original on or before 31<sup>st</sup> March, 2017 failing of which the advance amount granted will be recovered from researcher which please note.**

Further, I am to inform you that the researcher will have to utilize the sanctioned amount before 31<sup>st</sup> March, 2017 and submit original bills/vouchers of the expenditure along with Utilization Certificate (copy enclosed) duly certified by the Principal /Director /Head /Institute /University Department/College, to the A.P.D. Section, after verification through the Accounts Section, Gr. Floor, Room No. 13, Fort, Mumbai - 400 032.

The report of the research work carried out by the concerned researcher will have to be submitted to the University on or before 31<sup>st</sup> July, 2017.

The Principal/Head of the Institute are requested to inform the researcher accordingly and arrange to forward his/her undertaking along with RTGS Form immediately to enable this office to release first instalment of the research grant, accordingly.

Yours faithfully,

REGISTRAR



Since 1962

# Vivekanand Education Society's Institute of Technology

(Affiliated to University of Mumbai, Approved by AICTE & Recognized by Govt. of Maharashtra)

University of Mumbai

Research Project No: 502

NAME OF THE RESEARCHER: Dr. Saylee M. Ghangre  
LECTURE IN Electronic & Tele Communication

AMOUNT SANCTIONED: Rs. 20000/-

Ref No. APD/237/429 of 2017  
16<sup>th</sup> January, 2017

To,  
The Principal,  
Vivekanand Edu. Soc's Inst. of Technology,  
Collector Colony,  
Chembur,  
Mumbai - 400 074.

Sir/Madam,

With reference to the Research Proposal forwarded by you in respect of Shri/Smt/Kum Dr. Saylee M. Ghangre, I am directed to inform you that the said proposal has been considered by the University and the Committee has recommended research grant as quoted above to the researcher.

The sanctioned amount will be disbursed in two instalments. The first instalment of 50% of the sanctioned amount will be disbursed within 15 days on receiving undertaking and RTGS Form (copy enclosed) from the researcher.

The researcher is expected to spend 50% amount initially from his/her own resources to carry out the work. Please note that 50% balance amount, out of sanctioned grant will be released on the submission of utilization certificate including bills/vouchers/receipts in original on or before 31<sup>st</sup> March, 2017 failing of which the advance amount granted will be recovered from researcher which please note.

Further, I am to inform you that the researcher will have to utilize the sanctioned amount before 31<sup>st</sup> March, 2017 and submit original bills/vouchers of the expenditure along with Utilization Certificate (copy enclosed) duly certified by the Principal /Director /Head /Institute /University Department/College, to the A.P.D. Section, after verification through the Accounts Section, Gr. Floor, Room No. 13, Fort, Mumbai - 400 032.

The report of the research work carried out by the concerned researcher will have to be submitted to the University on or before 31<sup>st</sup> July, 2017.

The Principal/Head of the Institute are requested to inform the researcher accordingly and arrange to forward his/her undertaking along with RTGS Form immediately to enable this office to release first instalment of the research grant, accordingly.

Yours faithfully,

  
For REGISTRAR





# Vivekanand Education Society's Institute of Technology

(Affiliated to University of Mumbai, Approved by AICTE & Recognized by Govt. of Maharashtra)

University of Mumbai  
Research Project No: 500  
NAME OF THE RESEARCHER: Shri Chandan Singh Rawat  
LECTURE IN: I.T.C.  
AMOUNT SANCTIONED: Rs. 50,000/-  
Ref No. APD-237/ of 2017  
January, 2017

To,  
The Principal,  
VESIT Inst of Technology  
Chembur  
Mumbai

Sir/Madam,

With reference to the Research Proposal forwarded by you in respect of Shri Smt Kum Chandan Singh Rawat, I am directed to inform you that the said proposal has been considered by the University and the Committee has recommended research grant as quoted above to the researcher.

The sanctioned amount will be disbursed in two instalments. The first instalment of 50% of the sanctioned amount will be disbursed within 15 days on receiving undertaking and RTGS Form (copy enclosed) from the researcher.

The researcher is expected to spend 50% amount initially from his/her own resources to carry out the work. Please note that 50% balance amount, out of sanctioned grant will be released on the submission of utilization certificate including bills/vouchers/receipts in original on or before 31<sup>st</sup> March, 2017 failing of which the advance amount granted will be recovered from researcher which please note.

Further, I am to inform you that the researcher will have to utilize the sanctioned amount before 31<sup>st</sup> March, 2017 and submit original bills/vouchers of the expenditure along with Utilization Certificate (copy enclosed) duly certified by the Principal /Director /Head /Institute /University Department/College, to the A.P.D. Section, after verification through the Accounts Section, Gr. Floor, Room No. 13, Fort, Mumbai - 400 032.

The report of the research work carried out by the concerned researcher will have to be submitted to the University on or before 31<sup>st</sup> July, 2017.

The Principal/Head of the Institute are requested to inform the researcher accordingly and arrange to forward his/her undertaking along with RTGS Form immediately to enable this office to release first instalment of the research grant accordingly.

Yours faithfully,

  
For REGISTRAR





Since 1962

# Vivekanand Education Society's Institute of Technology

(Affiliated to University of Mumbai, Approved by AICTE & Recognized by Govt. of Maharashtra)

University of Mumbai

Research Project No: 499

NAME OF THE RESEARCHER: Mrs. Jyoti A. Bagate

LECTURE IN ETC

AMOUNT SANCTIONED: Rs. 4000/-

Ref No. APD/237/ of 2017  
January, 2017

To,  
The Principal,  
VES's Inst of Technology  
Chembur,  
Mumbai

Sir/Madam,

With reference to the Research Proposal forwarded by you in respect of Shri/Smt/Kum Jyoti A. Bagate, I am directed to inform you that the said proposal has been considered by the University and the Committee has recommended research grant as quoted above to the researcher.

The sanctioned amount will be disbursed in two instalments. The first instalment of 50% of the sanctioned amount will be disbursed within 15 days on receiving undertaking and RTGS Form (copy enclosed) from the researcher.

The researcher is expected to spend 50% amount initially from his/her own resources to carry out the work. **Please note that 50% balance amount, out of sanctioned grant will be released on the submission of utilization certificate including bills/vouchers/receipts in original on or before 31<sup>st</sup> March, 2017 failing of which the advance amount granted will be recovered from researcher which please note.**

Further, I am to inform you that the researcher will have to utilize the sanctioned amount before 31<sup>st</sup> March, 2017 and submit original bills/vouchers of the expenditure along with Utilization Certificate (copy enclosed) duly certified by the Principal /Director /Head /Institute /University Department/College, to the A.P.D. Section, after verification through the Accounts Section, Gr. Floor, Room No. 13, Fort, Mumbai - 400 032.

The report of the research work carried out by the concerned researcher will have to be submitted to the University on or before 31<sup>st</sup> July, 2017.

The Principal/Head of the Institute are requested to inform the researcher accordingly and arrange to forward his/her undertaking along with RTGS Form immediately to enable this office to release first instalment of the research grant, accordingly.

Yours faithfully,

  
For REGISTRAR



# Vivekanand Education Society's Institute of Technology

(Affiliated to University of Mumbai, Approved by AICTE & Recognized by Govt. of Maharashtra)

University of Mumbai

Research Project No: 525

NAME OF THE RESEARCHER: Ms. Manisha P. Toshi  
LECTURE IN Electronic & Tele Communication  
AMOUNT SANCTIONED: Rs. 22,000/-

Ref No. APD/237/429 of 2017

16<sup>th</sup> January, 2017

To,  
The Principal,  
Vivekanand Edu. Soc.,  
Inst. of Technology,  
Chembur,  
Mumbai - 400074.

Sir/Madam,

With reference to the Research Proposal forwarded by you in respect of Shri/Smt/Kum Ms. Manisha P. Toshi, I am directed to inform you that the said proposal has been considered by the University and the Committee has recommended research grant as quoted above to the researcher.

The sanctioned amount will be disbursed in two instalments. The first instalment of 50% of the sanctioned amount will be disbursed within 15 days on receiving undertaking and RTGS Form (copy enclosed) from the researcher.

The researcher is expected to spend 50% amount initially from his/her own resources to carry out the work. **Please note that 50% balance amount, out of sanctioned grant will be released on the submission of utilization certificate including bills/vouchers/receipts in original on or before 31<sup>st</sup> March, 2017 failing of which the advance amount granted will be recovered from researcher which please note.**

Further, I am to inform you that the researcher will have to utilize the sanctioned amount before 31<sup>st</sup> March, 2017 and submit original bills/vouchers of the expenditure along with Utilization Certificate (copy enclosed) duly certified by the Principal /Director /Head /Institute /University Department/College, to the A.P.D. Section, after verification through the Accounts Section, Gr. Floor, Room No. 13, Fort, Mumbai - 400 032.

The report of the research work carried out by the concerned researcher will have to be submitted to the University on or before 31<sup>st</sup> July, 2017.

The Principal/Head of the Institute are requested to inform the researcher accordingly and arrange to forward his/her undertaking along with RTGS Form immediately to enable this office to release first instalment of the research grant, accordingly.

Yours faithfully,

  
For REGISTRAR



# Vivekanand Education Society's Institute of Technology

(Affiliated to University of Mumbai, Approved by AICTE & Recognized by Govt. of Maharashtra)

## Index

Sr.No.	Content
1.	General Information
2.	Project details
3.	Paper published in International conference and IJRISE
4.	Utilization Certificate
5.	Expenditure details
6.	Bills(Components, Conference, travelling)

*Danjan*



# Vivekanand Education Society's Institute of Technology

Since 1962

(Affiliated to University of Mumbai, Approved by AICTE & Recognized by Govt. of Maharashtra)

## Part A: General Information:

1.	Basic Subject area of Research	Wireless Networks	
2.	Title of the Proposed Project	<b>Video Streaming with Multipath TCP and Enhanced Security</b>	
3.	Name Qualification and Designation of the Principal Investigator/Co-Investigator	Dr. Ranjan Bala Jain. PhD Professor Department of EXTC V.E.S.I.T Chembur Mumbai	
4.	Teaching and Research Experience of the Investigator	18 Years	
5.	Name and address of the Institution where the proposal will be executed	Vivekanand Education Society's Institute Of Technology Collector colony, Chembur, Mumbai-74	
6.	Whether the college /University is approved by the University	Yes	
7.	Details of Facilities provided/to be made available at the college/university	1. Computing Facilities 2. Internet Facility for Testing	
8.	Have you ever applied for Minor Research Project? If yes give Details	No	
9.	Whether the project or part of project is approved by the University for the Doctoral Degrees If yes, give details	No	
10.	Details of the Research project and Research Funding major/Minor received in the past and/ongoing projects.	None	





## Part B: Project Details:

### 1.1 Project Title:

### Video Streaming with Multipath TCP and Enhanced Security

#### 1.2 Introduction:

Internet is the system of interconnected computer networks used to exchange data across the globe. There are multiple redundant paths available between any two devices on the internet. However, the internet still works on the Internet Protocol Suite (TCP/IP) which is strictly single path. The redundant paths are then used only when the primary path fails or congestion occurs. Devices and servers, today, are largely multi-homed (a single device has multiple interfaces available, to connect to the internet). For example, a laptop at least has three interfaces namely, Wi-Fi, USB Dongle and a wired Ethernet port. However, TCP is capable of using only one of these interfaces at a time hindering the optimal use of available resources. It uses a single IP address per device. TCP connection can not move from one IP address to another. One has to switch the TCP connection from one interface like Ethernet to Wi-Fi depending upon the requirement.

Video streaming is a very common use of the internet nowadays. Use of video streaming ranges from live matches and events to business conferences. But more important is, medical emergencies in Tele health care, where speed is vital. This is where TCP fails, because it still relies on a single path. Secondly, Exchange of sensitive data over the internet has increased over the last decade thus, making security a major concern for the users.

To solve the problem of switching, idea of Multipath TCP is proposed [1]. It uses **all the available interfaces simultaneously** to connect to the internet. In this, a single file which is to be transmitted, is divided into small segments and transmitted via multiple paths and rearranged at the receiver. This is possible because each interface is allocated different IP address. This improves the speed of transmission due to usage of all available paths. Individual encryption and decryption techniques used on different paths makes information more secure.

#### 1.3 Objectives:

Speed and Security are the two most important performance parameters of the internet. The project aims at implementing a Multipath TCP connection that **enhances speed and security of the session**. Specifically, we propose an algorithm to distribute the load on different paths depending upon their capacity. We call this algorithm as **Weighted Load Distribution**.



## 1.4 Methodology:

The video streaming over multipath TCP works on two layers, Application layer and Transport layer.

**1) Application layer:** This layer handles video capture, encoding and display.

a) **Video streaming:** This aspect of the project works on the application layer. The first step towards implementation is to take input from a web cam or raspi cam and encoding the same. Usually, a compressed form of the video signal is preferred for transmission over wireless networks.

b) **Video Decode & display:** The transmitted video is decoded before being displayed. The output video is expected to be displayed without losing original quality.

**2) Transport Layer:** The Multipath transmission and encryption are handled by transport layer.

a) **Establishment of multipaths:** Multipath TCP is an extension of regular TCP which enables a transport connection to simultaneously operate across multiple paths. This starts with setting up a TCP connection and extending it to different interfaces.

b) **Video Segmentation and Encryption:** Next, the captured video is segmented in to various sizes depending upon the capacity of available paths. The paths chosen are wired Ethernet, 3G path and Wi-Fi. The different encryption techniques are used on different paths. At the receiver, the received segments are decrypted and rearranged to form the original data sequence.

The video streaming over wireless networks using multipath TCP will be implemented in Raspberry pi and Multi Path TCP protocol in Linux kernel. Figure 1 shows the block diagram of multi path TCP protocol implementation.

In Figure 1 sender and receiver are represented by host A and B. Before segmentation, the multipath capability of other end receiver is checked by MP\_CAPABLE command. If receiver has desired capability, it responds by sending ACK\_CAPABLE. After this handshaking, multipaths like 3G, Wi-Fi route and Ethernet cable are added using MP\_JOIN command. The existence of multipaths is indicated by presence of multiple addresses by host. After adding all paths, segmentation and encryption of video are performed and transmitted via multipaths. The speed increase is achieved due to aggregation of bandwidth of all paths. Segmentation depends upon the capacity of all multipaths. The decryption and rearrangement of data takes place at the transport layer of host B. Finally decoding and display are done at the application layer of host B.

Thus a secure and faster data transmission can be achieved via weighted load distribution multipath TCP protocol. Once the data transmission is over, multipath connections are opened up for new connection establishment.



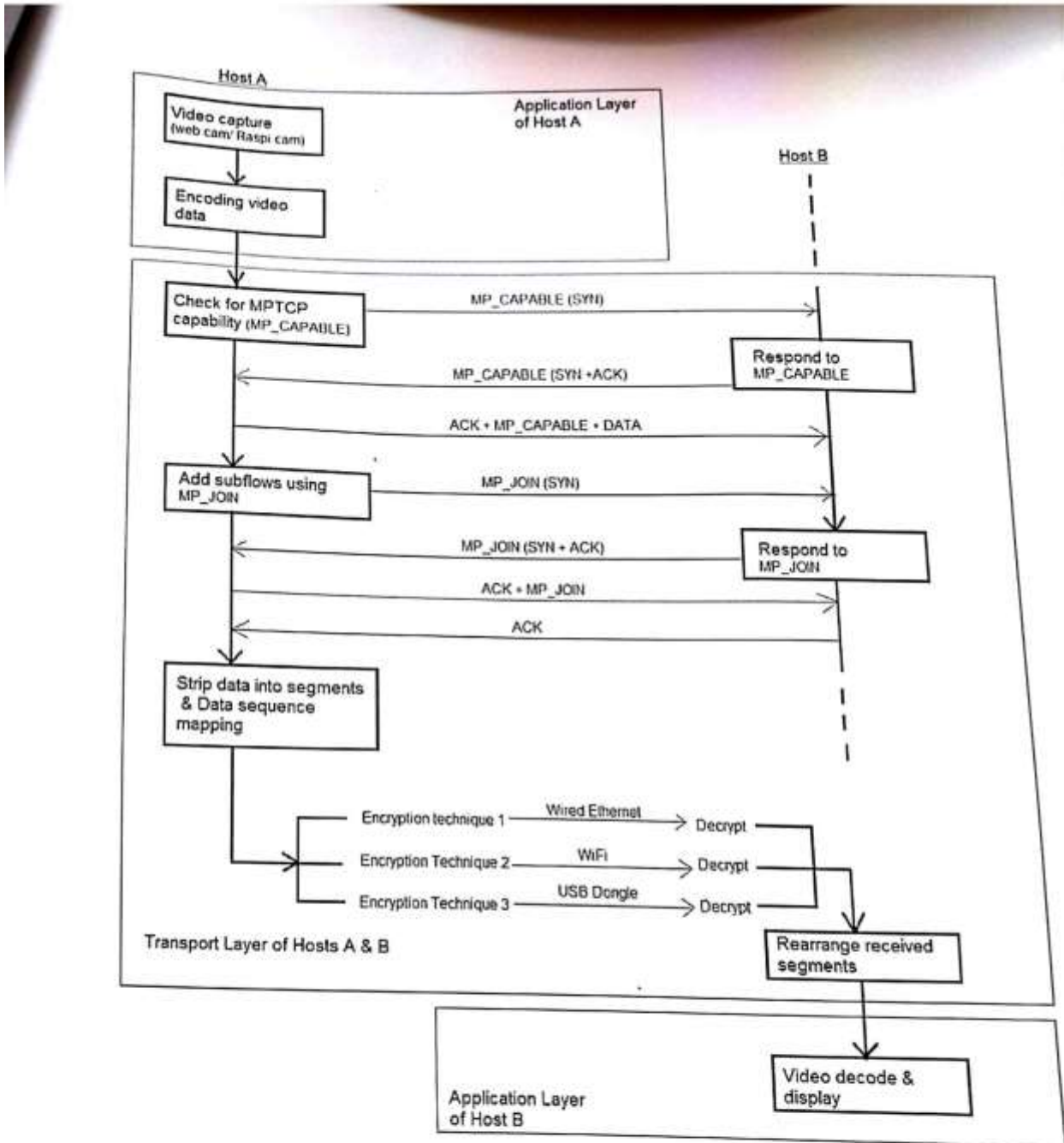

Figure 1: Flow of Implementation of Multipath TCP for Video Streaming





## 1.5 Transport Layer And MPTCP Sub-Flows

MPTCP is an extension to existing TCP protocol at transport layer. Multipath TCP modifies TCP so that it presents a standard TCP interface to applications, while in fact spreading data across several sub-flows.

This layer provides host-to-host communication needed as per the application. It is responsible for the delivery of the complete message to the receiver. It provides services such as connection-oriented data stream support, reliability, flow control, error control, congestion avoidance and multiplexing. In addition to the gains in throughput from inverse multiplexing, links may be added or dropped as the user moves in or out of coverage without disrupting the end-to-end TCP connection. Figure 2 shows TCP sub-flows involved in an MPTCP connection. For example, consider a mobile device connected to the internet through both mobile data as well as Wi-Fi connection. In a TCP session, only one of the two connections is active at a time. If the mobile user moves out of the Wi-Fi coverage area, the session is disrupted until another TCP session is set up through mobile data. However, in the case of MPTCP, the session is rescued by the mobile data.

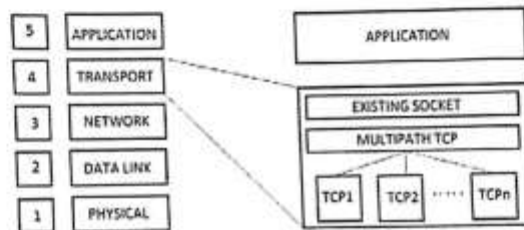

Figure 2: MPTCP in Transport Layer of TCP/IP model

This is because; the data operates as a backup along with the primary Wi-Fi connection. The problem of link handover is thus solved by abstraction in the transport layer without any special mechanisms at the network or link level.

## 1.6 MPTCP Connection Establishment

An MPTCP connection is essentially built on a TCP connection. The idea is to setup a basic TCP connection, using three-way handshaking, and to add sub-flows to the existing TCP connection to extend it to multiple paths.

### A. ESTABLISHING A TCP CONNECTION

The three-way handshaking signals, as shown in Figure 6, are sequential. The server is passive open, i.e. it is open to accept a connection initiated by a client. The client (active open) extends a





TCP connection request with a packet, SYN flag high. This ensures that if an ACK is received from the server, in response to the SYN, there can be a flow of data traffic from the client to the server.

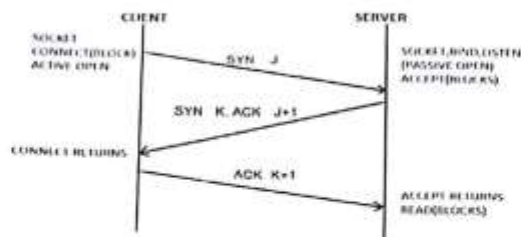

Figure 3: TCP Three Way Handshaking

The server also must issue a similar SYN connection to the client to ensure a bidirectional flow of traffic. Hence the server piggybacks its own SYN signal on the ACK response for the received SYN. Thus, the second handshaking signal includes an ACK and an SYN. Further, the client must reply to the received SYN signal with an acknowledgment. But, with the exchange of SYN and ACK between client and server, data can be sent from the client to the server. Hence the last packet carries data from the client to the server and carries the final ACK flag with it. Figure 6 illustrates how an MPTCP connection is setup

### B. EXTENDING A TCP CONNECTION TO MPTCP

The two important signals included for MPTCP connection are MP\_CAPABLE and MP\_JOIN. Figures 4.1, 4.2, 4.3 explain how MP\_CAPABLE, MP\_JOIN, and ADD\_ADDR signals are exchanged between the client and the server.

MP\_CAPABLE is the signal that ensures if the server is capable of simultaneous multiple TCP connections. Similarly, there should be an MP\_CAPABLE signal from the server to the client. Once both the parties have ensured the capability to make multiple connections, the next signal used is MP\_JOIN. MP\_JOIN is used to add sub-flows to set up multiple paths, over an existing TCP connection. ADD\_ADDR is then used to add the potential addresses of sub-flows. [9] Figure 1 illustrates the complete MPTCP connection between two hosts A and B.



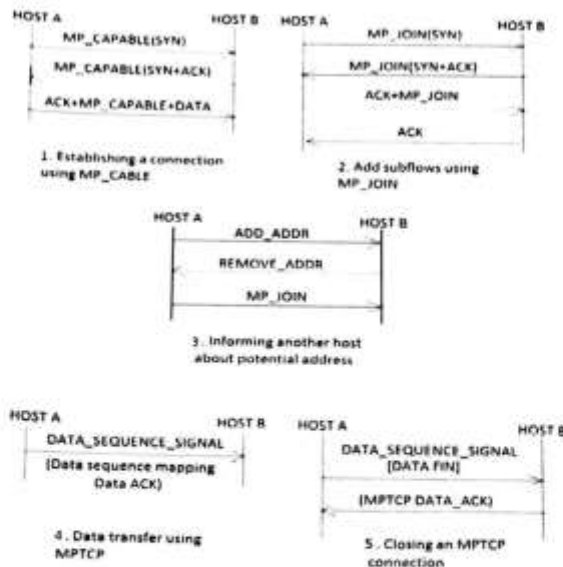

Figure 4: MPTCP Handshaking and Data Transfer

## 1.7 Security With MPTCP

Providing security of data transmission and prevention of data sniffing is one of the applications of Multipath TCP and also the main aspect of this paper, but this brings its own set of threats. The fundamental goal is the security of MPTCP, to be "no worse" than regular TCP today, and the key security requirements are:

To ensure that the hosts involved in a sub-flow handshake are the same as during the original connection set-up.

To ensure that a host can accept data at a new address before using it as a part of a connection

To make sure that a request to add/remove a sub-flow is 'fresh'.

The project aims at creating a secure MPTCP connection. First the numbers of interfaces are checked at both the client and server. The smaller of the two is chosen for number of sub-flows in the MPTCP connection. At the server end, the data is broken down into smaller segments. Suppose there are two interfaces over which the transmission is taking place, these two interfaces use same encryption techniques but different keys. Data which is broken down into segments is randomly sent over these two paths having different encryption keys. The data segments are received, decrypted and rearranged at the client side.



In TCP, only one path exists and only one encryption key is used. Once the key is known data segments can be sniffed and decrypted easily. In MPTCP using two encryption keys and sending the data in a random order, makes it much more difficult to decrypt the data. Since the segments are not contiguous, even if one sub-flow is hacked, the packets sniffed will contain random segments. This will make decryption of the data more difficult.

## 1.8 Results

This project focuses on enhancing the speed and security of an MPTCP session. An MPTCP session with two sub-flows, between two hosts was implemented. Advanced Encryption Standard (AES) encryption technique with two different keys on two different sub-flows was used. Execution time for MPTCP includes set-up time of all sub-flows, transmission time of the file segments and decryption and rearrangement of the segments at the receiver end. The execution times recorded during transmission of files of different sizes are shown in Table 1.

**Table 1: Execution time for transmission of different files with TCP and MPTCP**

	File size = 200 MB	File Size = 10 MB	File size = 1 MB
Execution Time for TCP (Sec)	421	20	2
Execution time for MPTCP (Sec)	315	16	2

For a TCP session, the execution time includes setup time of only one flow, transmission time of the entire file and decryption of the received data at receiver. In MPTCP

however, the excess time required to setup multiple sub-flows is compensated by the faster transmission of data as segments are transmitted simultaneously on all sub-flows. This is observed as the file size increases. For a smaller file size, the overhead of setup time defeats the purpose of MPTCP as it is much greater than the transmission time itself. However, for a larger file size, the transmission time is much greater than the setup time. Thus, only a fraction of the time saved in simultaneous transmission of segments is used in setup time of multiple sub-flows. However, this setup time is in the order of milliseconds and cannot be practically measured in the simulation.

Also, this implementation uses different keys on each sub-flow in an attempt to increase security of the session. It also implements randomization of data segments to ensure that even if one of the sub-flows is hacked, the hacker does not get access to a contiguous data segment but only random bits that are difficult to put together.





## 1.9 Conclusion

Use of multipath TCP in video streaming helps to bridge the gap between remote rural areas and more advanced urban areas. MPTCP allows simultaneous use of multiple paths (interfaces) thus making the connection more robust. It offers flexibility to an application, when multiple connection options are available. Benefits of this include, a better resource utilisation, better throughput and less failures. The implementation of MPTCP is performed with two sub-flows for various file sizes. It is observed that, as the file size increases, implementation of MPTCP session gives better throughput. This is because the setup time remains constant irrespective of the file size. But the time gained in simultaneous transmission of data segments increases with file size. On each sub-flow encryption is performed with a different key. Thus, different keys on each sub-flow provide enhanced security.

The implementation of multipath TCP will not only increase the speed but also provide security. It will benefit the society as follows:

- Rural communities and citizens will be benefited by Tele-healthcare systems based on multipath TCP.
- Educational institutes will be able to impart quality education with multipath TCP based content delivery. Live lectures from IIT can be displayed at remote areas.
- It is said the with 10% increase in high speed content delivery, economic growth increases by 1.3%. This will strengthen Digital India programme.

## References

- [1] Damon Wischik, Costin Raiciu, Adam Greenhalgh, Mark Handley "Design, implementation and evaluation of congestion control for multipath TCP" University College London
- [2] M S Priyadarshini, "Streaming Video with MultiPath TCP in WirelessNetworks" International Journal of Engineering Research & Technology (IJERT), Vol. 5 Issue 04, April-2016, Embedded Systems Karunya University Coimbatore, India
- [3] Costin Raiciu, Michio Honda, Christoph Paasch, Fabien Duchene, Sebastien Barre, Olivier Bonaventure and Mark Handley, Alan Ford, "How Hard Can It Be? Designing and Implementing a Deployable Multipath TCP" University of London
- [4] <http://www.slashroot.in/what-tcp-multipath-and-how-does-multipath-tcp-work>
- [5] <https://www.multipath-tcp.org/pmwiki.php/Main/HomePage> Olivier Bonaventure, University of Louvain, Belgium; Mark Handley, University College, London; Costin Raiciu, University Politehnica of Bucharest; "An Overview Of MultiPath TCP" login, October 2012 VOL.37, NO.5
- [6] How Hard Can It Be? Designing and Implementing a Deployable Multipath TCP Costin Raiciu, Christoph Paasch, Sebastien Barre, Alan Ford, Michio Honda, Fabien Duchene, Olivier Bonaventure and Mark Handley Universitatea Politehnica Bucuresti, Universite Catholique de Louvain Keio University, University College London







# Vivekanand Education Society's Institute of Technology

(Affiliated to University of Mumbai, Approved by AICTE & Recognized by Govt. of Maharashtra)

[7] Lukasz Apiecionek;Mark Sobczak;Wojciech Makowski;Tibor Vince.*Multi Path Transmission Control Protocol as a security solution*,2015 IEEE 13<sup>th</sup> International Scientific Conference on Informatics , DOI:10.1109/ Informatics.2015.7377802

[8] Data Communications and Networking, 4<sup>th</sup> edition, Behrouz Forouzan

[9] M. Sophia, Dr. A ShobhaRekh, *Streaming Video with MultiPath TCP in Wireless Networks*, International Journal of Engineering Research & Technology (IJERT) Vol. 5 Issue 04, April-2016

[10] Olivier Bonaventure, MPTCP Analyzer-multipat-tcp.org, August 23, 2016

[11] Michael Donahoo, Kenith Calvert, "TCP/IP Sockets in C: Practical Guide for Programers"

[12] Geoff Huston, *Multipath TCP*, APNIC Labs, 9 Jun 2015

*Note: On this work a paper is presented in International Conference on Emaanations in Modern Technology & Engineering March 4<sup>th</sup> -5<sup>th</sup> 2017, organised by Shri L. R. Tiwari College of Engineering , Mira Road Maharashtra.*

*Title: Solution for Speed and Security Multipath Transmission Control Protocol.*

*Paper is enclosed for reference*





# Vivekanand Education Society's Institute of Technology

(Affiliated to University of Mumbai, Approved by AICTE & Recognized by Govt. of Maharashtra)

## UTILIZATION CERTIFICATE

Certified that the sanctioned grant of **Rs. 25,000/- (Rupees Twenty Five Thousand only)** and received amount of first installment of Rs. 12,500/- (Rupees Twelve Thousand Five Hundred only) from the University of Mumbai, under the scheme of support for Minor Research Project entitled "**VIDEO STREAMING WITH MULTIPATH TCP and ENHANCED SECURITY**" by **Dr. Ranjan Bala Jain** has been fully utilized for the purpose for which it has sanctioned and in accordance with the terms and conditions laid down by the University.

Project No. 418

University Letter No. APD/237 OF Jan 2017

  
Principal Investigator

C.P.I.

Principal

Date: 29<sup>th</sup> March 2017

College Seal





# Vivekanand Education Society's Institute of Technology

Since 1962

(Affiliated to University of Mumbai, Approved by AICTE & Recognized by Govt. of Maharashtra)

University of Mumbai

Research Project No: 418

NAME OF THE RESEARCHER: Dr. Ranjan Bala Jain  
LECTURE IN: Electronic Engineering  
AMOUNT SANCTIONED: Rs. 25,000/-

Ref No. APD/237/ of 2017  
January, 2017

To,  
The Principal,  
Vivekanand Edu. Soc's  
Institute of Technology,  
Chembur,  
Mumbai - 400 074

Sir/Madam,

With reference to the Research Proposal forwarded by you in respect of Shri/Smt/Kum Dr. Ranjan Bala Jain, I am directed to inform you that the said proposal has been considered by the University and the Committee has recommended research grant as quoted above to the researcher.

The sanctioned amount will be disbursed in two instalments. The first instalment of 50% of the sanctioned amount will be disbursed within 15 days on receiving undertaking and RTGS Form (copy enclosed) from the researcher.

The researcher is expected to spend 50% amount initially from his/her own resources to carry out the work. **Please note that 50% balance amount, out of sanctioned grant will be released on the submission of utilization certificate including bills/vouchers/receipts in original on or before 31<sup>st</sup> March, 2017 failing of which the advance amount granted will be recovered from researcher which please note.**

Further, I am to inform you that the researcher will have to utilize the sanctioned amount before 31<sup>st</sup> March, 2017 and submit original bills/vouchers of the expenditure along with Utilization Certificate (copy enclosed) duly certified by the Principal /Director /Head /Institute /University Department/College, to the A.P.D. Section, after verification through the Accounts Section, Gr. Floor, Room No. 13, Fort, Mumbai - 400 032.

The report of the research work carried out by the concerned researcher will have to be submitted to the University on or before 31<sup>st</sup> July, 2017.

The Principal/Head of the Institute are requested to inform the researcher accordingly and arrange to forward his/her undertaking along with RTGS Form immediately to enable this office to release first instalment of the research grant, accordingly.

Yours faithfully,

  
For REGISTRAR





# Vivekanand Education Society's Institute of Technology

Since 1962

(Affiliated to University of Mumbai, Approved by AICTE & Recognized by Govt. of Maharashtra)

## MINOR RESEARCH PROJECT

Title: "VIDEO STREAMING WITH MULTIPATH TCP and ENHANCED SECURITY"

### EXPENDITURE

Sr. No.	Bill No.	Date of Bill	Particular/Purpose	Amount (Rs.)
1.	Royal Electronics 01/16-17/06	11/01/2017	Arduino, Wi-Fi, Zig bee and GSM modules	3074/-
2.	Royal Electronics 02/16-17/03	6/02/2017	GPS Module, Raspberry-pi and Pulse sensor	5035/-
3.	Royal Electronics 03/16-17/05	10/03/2017	Sensors: Ultrasonic, Temperature, Gas, DST11	699.60/-
4.	Royal Electronics 03/16-17/09	16/03/2017	Breadboard, LD 33, ESP01, I/O board	678.40/-
5.	Royal Electronics 03/16-17/26	28/03/2017	Ethernet Cable, holders, Connectors, 4G LTE, Raspberry starter kit, EHD	12514/-
6.	1173 (Receipt no.) (On line payment) N0471702478821 16	4/3/2017	International conference (International Journal Of Research in Science and Engineering) Topic: Solution for speed and security: Multipath TCP	3000/-
7.	Uber	4/3/2017	Travelling	668.16/-
			Total	25669.16/-

  
Principal Investigator

Date: 29<sup>th</sup> March 2017

Principal

College Seal







# Vivekanand Education Society's Institute of Technology

Since 1962

(Affiliated to University of Mumbai, Approved by AICTE & Recognized by Govt. of Maharashtra)

TAX INVOICE VEDCT  
2016-17/0004

Ext: 2521 1248  
Fax: 2521 1649

**ROYAL ELECTRONICS**  
TV, AUDIO, VIDEO, PHONE & CD SPARE PARTS  
Shop No 8-A, 82-Sai Deep Shopping Centre, Opp. Vaishali Hotel,  
N. G. Acharya Marg, Near Chembur Station, Chembur (E), Mumbai - 71.

M/s. DR. RANJAN BALAJAIN No. : 03/16-17/26  
MUMBAI Date: 28/3/17

Description	Quantity	Rate Per	Amount Rs.	P.
ETHERNET CABLE	1	350	350=00	
4G LTE DONGLE	1	2150	2150=00	
Raspberry Pi starter kit	1	950	950=00	
Linux OS CD	1	800	800=00	
Hard Disc 2TB. WD	1	6800	6800=00	
Holders & connectors	1	755	755=00	
			11805=00	
Rupees <u>Twelve thousand five hundred &amp; fourteen only.</u>			VAT 6%	709=00
			TOTAL	12514=00

VAT TIN 27100371597 V w.e.f. 1-4-06  
CST TIN 27100371597 C w.e.f. 1-4-06

Terms :  
1) Goods once sold will not be taken back.  
2) Subject to Mumbai Jurisdiction.

"I We hereby certify that this invoice is issued in accordance with the provisions of the Registration Certificate under the Maharashtra Value Added Tax Act 2002 is in force on the date on which the sale of the goods specified in this bill is made. The sale is made by me/us in the State of Maharashtra. The sale covered by this invoice has been effected by me/us and will be accounted for in the turnover of sales while filing my return."

**ROYAL ELECTRONICS**  
For Royal Electronics



# Vivekanand Education Society's Institute of Technology

Since 1962

(Affiliated to University of Mumbai, Approved by AICTE & Recognized by Govt. of Maharashtra)

VE 437/EXTC/2016-17/0004/0.

## TAX INVOICE

<b>ROYAL ELECTRONICS (CHEMBUR)</b> SHOP NO 8-A, 82 SAIDEEP SHOPPING CENTRE OPP VAISHALI HOTEL, N G ACHARYA MARG, NEAR CHEMBUR STN, CHEMBUR ( E ), MUMBAI - 400071		Invoice No <b>03/16-17/09</b>	Dated <b>16-Mar-2017</b>
E-mail : naresh_royal2000@hotmail.com Consignee <b>Dr. Ranjan Bala Jain</b> Mumbai		Delivery Note <b>03/16-17/09</b>	Model/Terms of Payment <b>Other Reference(s)</b>
		Supplier's Ref <b>03/16-17/09</b>	Buyer's Order No. <b>verbal</b>
		Buyer's Order No. <b>verbal</b>	Dated <b>16-Mar-2017</b>
		Despatch Document No. <b>By Road</b>	Dated <b>Mumbai</b>
		Despatched through <b>By Road</b>	Destination <b>Mumbai</b>
		Terms of Delivery	

Description of Goods	Quantity	Rate	per	Amount
Bread Board Small Size	1 PCS	50.00	PCS	50.00
ESP01 Socket	1 PCS	200.00	PCS	200.00
LD 33 REG.	1 PCS	40.00	PCS	40.00
I/o Board for Arduino	1 PCS	350.00	PCS	350.00
				640.00
<i>Output Vat @ 6%</i>			6 %	38.40
<b>Total</b>	<b>4 PCS</b>			<b>678.40</b>
				E & O E

Amount Chargeable (in words)  
 Rs. Six Hundred Seventy Eight and Forty paise Only

Company's VAT TIN : 27100371597V  
 Company's CST No. : 27100371597C

Declaration  
 "We hereby certify that my/our Registration Certificate under the Maharashtra Value Added Tax Act 2002 is in force on the date on which the sale of the goods specified in this tax invoice is made by me/us and that the transaction of sale covered by this tax invoice has been effected by me/us and it shall be accounted for in the turnover of sales while filing of return and the due tax, if any payable on the same has been paid or shall be paid."

This is a Computer Generated Invoice



for ROYAL ELECTRONICS (CHEMBUR)  
 Authorized Signatory





# Vivekanand Education Society's Institute of Technology

(Affiliated to University of Mumbai, Approved by AICTE & Recognized by Govt. of Maharashtra)

VEST/EXT/2016-17/0004/03

## TAX INVOICE

<p><b>ROYAL ELECTRONICS (CHEMBUR)</b>          SHOP NO 8-A, 82 SAIDEEP SHOPPING CENTRE          OPP VAISHALI HOTEL, N G ACHARYA MARG,          NEAR CHEMBUR STN, CHEMBUR ( E ),          MUMBAI - 400071</p> <p>E-mail : naresh_royal2000@hotmail.com          Consignee  <b>Dr. Ranjan Bala Jain</b>          Mumbai</p>	<table border="1" style="width: 100%; border-collapse: collapse;"> <tr> <td>Invoice No.</td> <td>Dated</td> </tr> <tr> <td><b>03/16-17/05</b></td> <td><b>10-Mar-2017</b></td> </tr> <tr> <td>Delivery Note</td> <td>Mode/Terms of Payment</td> </tr> <tr> <td>Supplier's Ref.</td> <td>Other Reference(s)</td> </tr> <tr> <td><b>03/16-17/05</b></td> <td></td> </tr> <tr> <td>Buyer's Order No.</td> <td>Dated</td> </tr> <tr> <td><b>verbal</b></td> <td><b>10-Mar-2017</b></td> </tr> <tr> <td>Despatch Document No.</td> <td>Dated</td> </tr> <tr> <td>Despatched through</td> <td>Destination</td> </tr> <tr> <td><b>By Road</b></td> <td><b>Mumbai</b></td> </tr> <tr> <td colspan="2">Terms of Delivery</td> </tr> </table>	Invoice No.	Dated	<b>03/16-17/05</b>	<b>10-Mar-2017</b>	Delivery Note	Mode/Terms of Payment	Supplier's Ref.	Other Reference(s)	<b>03/16-17/05</b>		Buyer's Order No.	Dated	<b>verbal</b>	<b>10-Mar-2017</b>	Despatch Document No.	Dated	Despatched through	Destination	<b>By Road</b>	<b>Mumbai</b>	Terms of Delivery	
Invoice No.	Dated																						
<b>03/16-17/05</b>	<b>10-Mar-2017</b>																						
Delivery Note	Mode/Terms of Payment																						
Supplier's Ref.	Other Reference(s)																						
<b>03/16-17/05</b>																							
Buyer's Order No.	Dated																						
<b>verbal</b>	<b>10-Mar-2017</b>																						
Despatch Document No.	Dated																						
Despatched through	Destination																						
<b>By Road</b>	<b>Mumbai</b>																						
Terms of Delivery																							

  

Description of Goods	Quantity	Rate	per	Amount
Ultrasonic Senser	1 PCS	150.00	PCS	150.00
Temperature Senser	1 PCS	60.00	PCS	60.00
Gas Senser	1 PCS	300.00	PCS	300.00
DST 11 Senser	1 PCS	150.00	PCS	150.00
				660.00
<i>Output Vat @ 6%</i>			6 %	39.60
<b>Total</b>	<b>4 PCS</b>			<b>699.60</b>

E & O. E

Amount Chargeable (in words)  
**Rs. Six Hundred Ninety Nine and Sixty paise Only**

Company's VAT TIN : 27100371597V Company's CST No. : 27100371597C Declaration "We hereby certify that my/our Registration Certificate under the Maharashtra Value Added Tax Act 2002 is in force on the date on which the sale of the goods specified in this tax invoice is made by me/us and that the transaction of sale covered by this tax invoice has been effected by me/us and it shall be accounted for in the turnover of sales while filing of return and the due tax, if any payable on the same has been paid or shall be paid."	 (for ROYAL ELECTRONICS (CHEMBUR) MUMBAI)
--	---

This is a Computer Generated Invoice







# Vivekanand Education Society's Institute of Technology

Since 1962

(Affiliated to University of Mumbai, Approved by AICTE & Recognized by Govt. of Maharashtra)

VESTI/ETIT/2016-17/0004/01

### TAX INVOICE

<p><b>ROYAL ELECTRONICS (CHEMBUR)</b> SHOP NO B-A, 82 SADEEP SHOPPING CENTRE OPP VAISHALI HOTEL, N G ACHARYA MARG, NEAR CHEMBUR STN, CHEMBUR (E), MUMBAI - 400071</p> <p>E-mail : naresh_royal2000@hotmail.com Consignee <b>Dr. Ranjan Bala Jain</b> Mumbai</p>	<table border="1" style="width: 100%; border-collapse: collapse;"> <tr> <td>Invoice No.</td> <td>01/16-17/06</td> <td>Dated</td> <td>11-Jan-2017</td> </tr> <tr> <td>Delivery Note</td> <td></td> <td>Mode/Terms of Payment</td> <td></td> </tr> <tr> <td>Supplier's Ref</td> <td>01/16-17/06</td> <td>Other Reference(s)</td> <td></td> </tr> <tr> <td>Buyer's Order No</td> <td>verbal</td> <td>Dated</td> <td>11-Jan-2017</td> </tr> <tr> <td>Despatch Document No.</td> <td></td> <td>Dated</td> <td></td> </tr> <tr> <td>Despatched through</td> <td>By Road</td> <td>Destination</td> <td>Mumbai</td> </tr> <tr> <td>Terms of Delivery</td> <td colspan="3"></td> </tr> </table>	Invoice No.	01/16-17/06	Dated	11-Jan-2017	Delivery Note		Mode/Terms of Payment		Supplier's Ref	01/16-17/06	Other Reference(s)		Buyer's Order No	verbal	Dated	11-Jan-2017	Despatch Document No.		Dated		Despatched through	By Road	Destination	Mumbai	Terms of Delivery			
Invoice No.	01/16-17/06	Dated	11-Jan-2017																										
Delivery Note		Mode/Terms of Payment																											
Supplier's Ref	01/16-17/06	Other Reference(s)																											
Buyer's Order No	verbal	Dated	11-Jan-2017																										
Despatch Document No.		Dated																											
Despatched through	By Road	Destination	Mumbai																										
Terms of Delivery																													

Description of Goods	Quantity	Rate	per	Amount
Arduino - Uno	1 PCS	550.00	PCS	550.00
Wi-Fi Module	1 PCS	250.00	PCS	250.00
Zigbee Module	1 PCS	1,150.00	PCS	1,150.00
Gsm Module	1 PCS	950.00	PCS	950.00
				2,900.00
Output Vat @ 6%			6 %	174.00
<b>Total</b>	<b>4 PCS</b>			<b>3,074.00</b>

E & O. E.

Amount Chargeable (in words)  
Rs. Three Thousand Seventy Four Only

Company's VAT TIN : 27100371597V  
Company's CST No. : 27100371597C

**Declaration**  
"We hereby certify that my/our Registration Certificate under the Maharashtra Value Added Tax Act 2002 is in force on the date on which the sale of the goods specified in this tax invoice is made by me/us and that the transaction of sale covered by this tax invoice has been effected by me/us and it shall be accounted for in the turnover of sales while filing of return and the due tax, if any payable on the same has been paid or shall be paid."

This is a Computer Generated Invoice

for ROYAL ELECTRONICS (CHEMBUR)





# Vivekanand Education Society's Institute of Technology

(Affiliated to University of Mumbai, Approved by AICTE & Recognized by Govt. of Maharashtra)

## Third Party Funds Transfer

[Print This Page](#)

**Congratulations, your RTGS/NEFT transaction is completed successfully!**  
You've won yourself a Special Offer.



**Avail now**

\*T&C apply

To Other Bank (NEFT)

STEP	STEP	STEP
①	②	③
Enter Details	Confirm transaction	Acknowledgement
Reference Number	N047170247882116	
From Account	00151000029840	
Beneficiary Name	SHRI I. R TIWARI COLLEGE OF ENGINEERING	
Beneficiary IFSC Code	CORP0000455	
Beneficiary Account Number / Credit Card Number	045500201001597	
Bank Name	CORPORATION BANK	
Transfer Amount	<u>3,000.00</u>	
Transfer Description	conference fee	
Mode of Communication	SMS	
Communication detail	9987548196	

**Make Another Transfer**

### Note:

- The actual time taken to credit the account depends on the time taken by the Payee's Bank to process the payment.
- The money will reach the Payee's bank within the time stipulated by the Reserve Bank of India.
- HDFC Bank is not responsible for any charges / commission of any kind levied/charged by the Beneficiary Bank.
- For details on safe NetBanking practices please [click here](#)





# Vivekanand Education Society's Institute of Technology

(Affiliated to University of Mumbai, Approved by AICTE & Recognized by Govt. of Maharashtra)

University of Mumbai

Research Project No: 565

NAME OF THE RESEARCHER: Dr. Nupur Givi

LECTURE IN Comp. Engg.

AMOUNT SANCTIONED: Rs. 20000/-

RefNo. APD/237/429 of 2017

16 January, 2017

To,  
The Principal,

Vivekanand Education Society's  
Institute of Technology,  
H.A.M.C., Collectors Colony,  
Chembur - 400 074

Sir/Madam,

With reference to the Research Proposal forwarded by you in respect of Shri/Smt/Kum Dr. Nupur Givi, I am directed to inform you that the said proposal has been considered by the University and the Committee has recommended research grant as quoted above to the researcher.

The sanctioned amount will be disbursed in two instalments. The first instalment of 50% of the sanctioned amount will be disbursed within 15 days on receiving undertaking and RTGS Form (copy enclosed) from the researcher.

The researcher is expected to spend 50% amount initially from his/her own resources to carry out the work. **Please note that 50% balance amount, out of sanctioned grant will be released on the submission of utilization certificate including bills/vouchers/receipts in original on or before 31<sup>st</sup> March, 2017 failing of which the advance amount granted will be recovered from researcher which please note.**

Further, I am to inform you that the researcher will have to utilize the sanctioned amount before 31<sup>st</sup> March, 2017 and submit original bills/vouchers of the expenditure along with Utilization Certificate (copy enclosed) duly certified by the Principal /Director /Head /Institute /University Department/College, to the A.P.D. Section, after verification through the Accounts Section, Gr. Floor, Room No. 13, Fort, Mumbai - 400 032.

The report of the research work carried out by the concerned researcher will have to be submitted to the University on or before 31<sup>st</sup> July, 2017.

The Principal/Head of the Institute are requested to inform the researcher accordingly and arrange to forward his/her undertaking along with RTGS Form immediately to enable this office to release first instalment of the research grant, accordingly.

Yours faithfully,

  
For REGISTRAR

Scanned with CamScanner



Since 1962

# Vivekanand Education Society's Institute of Technology

(Affiliated to University of Mumbai, Approved by AICTE & Recognized by Govt. of Maharashtra)

University of Mumbai

Research Project No: 463

NAME OF THE RESEARCHER: Mrs. Lifna C.S.

LECTURE IN I.T.

AMOUNT SANCTIONED: Rs. 23,000/-

Ref No. APD/237/ of 2017

January, 2017

To,  
The Principal,  
VES Inst of Tech.  
Chembur.  
Mumbai

Sir/Madam,

With reference to the Research Proposal forwarded by you in respect of Shri/Smt/Kum Lifna C.S., I am directed to inform you that the said proposal has been considered by the University and the Committee has recommended research grant as quoted above to the researcher.

The sanctioned amount will be disbursed in two instalments. The first instalment of 50% of the sanctioned amount will be disbursed within 15 days on receiving undertaking and RTGS Form (copy enclosed) from the researcher.

The researcher is expected to spend 50% amount initially from his/her own resources to carry out the work. **Please note that 50% balance amount, out of sanctioned grant will be released on the submission of utilization certificate including bills/vouchers/receipts in original on or before 31<sup>st</sup> March, 2017 failing of which the advance amount granted will be recovered from researcher which please note.**

Further, I am to inform you that the researcher will have to utilize the sanctioned amount before 31<sup>st</sup> March, 2017 and submit original bills/vouchers of the expenditure along with Utilization Certificate (copy enclosed) duly certified by the Principal /Director /Head /Institute /University Department/College, to the A.P.D. Section, after verification through the Accounts Section, Gr. Floor, Room No. 13, Fort, Mumbai - 400 032.

The report of the research work carried out by the concerned researcher will have to be submitted to the University on or before 31<sup>st</sup> July, 2017.

The Principal/Head of the Institute are requested to inform the researcher accordingly and arrange to forward his/her undertaking along with RTGS Form immediately to enable this office to release first instalment of the research grant, accordingly.

Yours faithfully,

  
For REGISTRAR





Since 1962

# Vivekanand Education Society's Institute of Technology

(Affiliated to University of Mumbai, Approved by AICTE & Recognized by Govt. of Maharashtra)

University of Mumbai

NAME OF THE RESEARCHER: Mr. Jayasree Ramakrishnan Research Project No: 419  
LECTURE IN Electronic Engineering  
AMOUNT SANCTIONED: Rs. 25,000/-

Ref No. APD/237/ of 2017  
January, 2017

To,  
The Principal,  
V.E.S.'s Inst. of Technology,  
Chembur,  
Mumbai.

Sir/Madam,

With reference to the Research Proposal forwarded by you in respect of Shri/Smt/Kum Jayasree Ramakrishnan I am directed to inform you that the said proposal has been considered by the University and the Committee has recommended research grant as quoted above to the researcher.

The sanctioned amount will be disbursed in two instalments. The first instalment of 50% of the sanctioned amount will be disbursed within 15 days on receiving undertaking and RTGS Form (copy enclosed) from the researcher.

The researcher is expected to spend 50% amount initially from his/her own resources to carry out the work. Please note that 50% balance amount, out of sanctioned grant will be released on the submission of utilization certificate including bills/vouchers/receipts in original on or before 31<sup>st</sup> March, 2017 failing of which the advance amount granted will be recovered from researcher which please note.

Further, I am to inform you that the researcher will have to utilize the sanctioned amount before 31<sup>st</sup> March, 2017 and submit original bills/vouchers of the expenditure along with Utilization Certificate (copy enclosed) duly certified by the Principal /Director /Head /Institute /University Department/College, to the A.P.D. Section, after verification through the Accounts Section, Gr. Floor, Room No. 13, Fort, Mumbai - 400 032.

The report of the research work carried out by the concerned researcher will have to be submitted to the University on or before 31<sup>st</sup> July, 2017.

The Principal/Head of the Institute are requested to inform the researcher accordingly and arrange to forward his/her undertaking along with RTGS Form immediately to enable this office to release first instalment of the research grant, accordingly.

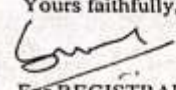
Yours faithfully,  
  
For REGISTRAR

Scanned with CamScanner





# Vivekanand Education Society's Institute of Technology

(Affiliated to University of Mumbai, Approved by AICTE & Recognized by Govt. of Maharashtra)

भारतीय अन्तरिक्ष अनुसंधान संगठन  
अन्तरिक्ष विभाग  
भारत सरकार  
अन्तरिक्ष भवन  
न्यू बी ई एल रोड, बेंगलूर - 560 231, भारत  
दूरभाष : +91 80 2341 5474  
फैक्स :



Indian Space Research Organisation  
Department of Space  
Government of India  
Antariksh Bhavan  
New BEL Road, Bangalore - 560 231, India  
Telephone : +91 80 2341 5474  
Fax :

Dr. S. Seetha  
Programme Director, SSPO

Telephone: 080-23416271/22172074  
Fax: 080 - 23419190  
E-mail: seetha@isro.gov.in

ISRO/SSPO/MOM-AO/2016-17

August 8, 2016

Dear Mr. Abhijit Sharad Shete,

**Subject: Research proposal under Mars Orbiter Mission – Announcement of opportunity – release of fund - reg.**

This has reference to your submission of the research proposal "*Martian landform segmentation based on structural similarity*" for funding under Mars Orbiter Mission Announcement of Opportunity (MOM-AO). The domain experts in Department of Space have reviewed the proposal. I wish to inform you that, Chairman, ISRO/Secretary, DOS has approved the following:

1. Funding of the project under MOM-AO for a period of 3 years at a total outlay of ₹ 3,08,000 (Rupees Three Lakhs Eight Thousand Twenty only) towards meeting the expenditure of the project (budget details enclosed).
2. Release of grant of ₹ 1,10,000 (Rupees One Lakh Ten thousand only) towards meeting the first year expenditure of the project.

The approval is subject to fulfillment of the following:

- (a) You will have to submit Annual Progress Report (APR), at the end of the year, indicating the progress of the work accomplished during the first year (to enable renewal of the project for second year). One copy of report should be sent to Shri Satadru Bhattacharya, MOM-AO Coordinator, Planetary Sciences Division, BPSG/EPISA, Space Applications Centre, Jodhpur-Tekra, Ambawadi Vistar P.O.Ahmedabad-380 015, India and two copies to the undersigned.
- (b) You will have to submit two copies of the Fund Utilization Certificate (FUC) and Audited Accounts Statement (AAS) on completion of the **first** year of the project (to enable renewal of the project for **second** year). **The FUC and AAS** should be sent to the (i) Pay & Accounts Officer, Department of Space, Antariksh Bhavan, New BEL Road, Bengaluru 560 231 with a copy to Shri Satadru Bhattacharya, MOM-AO Coordinator, Planetary Sciences Division, BPSG/EPISA, Space Applications Centre, Jodhpur-Tekra, Ambawadi Vistar P.O.Ahmedabad-380 015, and to the undersigned.
- (c) In addition, on conclusion of the project, you will have to send a comprehensive report covering total project activities and final fund utilization certificate.

भारतीय अन्तरिक्ष अनुसंधान संगठन / Indian Space Research Organisation



# Vivekanand Education Society's Institute of Technology

(Affiliated to University of Mumbai, Approved by AICTE & Recognized by Govt. of Maharashtra)

भारत सरकार  
अन्तरिक्ष विभाग  
अन्तरिक्ष भवन, न्यू बी ई एल रोड  
बेंगलूर - 560 231, भारत  
दूरभाष : 080 - 2217 2253/2217 2255  
फैक्स : 080 - 2341 6770



GOVERNMENT OF INDIA  
DEPARTMENT OF SPACE  
Antariksh Bhavan, New BEL Road  
Bangalore - 560 231, India.  
Telephone :080 - 2217 2253 / 2217 2255  
Grams : Space Fax : 080 - 2341 6770

No. DOS/PAO/GIA/2016-2017/18/344

Date:06/10/2016

Principal,  
VES Institute of Technology,  
Collectors Colony Road,  
Chembur, Mumbai

Sir,

Sub :- Credit of Rs. **1,10,000/-** to your A/c No. **0229201006042** through  
EFT on **01/10/2016**, vide Bank UTR No. **SBIN616275163777**, SSO  
-reg

\*\*\*\*\*

With reference to Departments Sanction Order No. B. 19013/9/2016-Sec.2 dated 10/08/2016 the grant amount of Rs. **1,10,000/-** (Rupees One lakh Ten Thousand Only) has been credited to A/c No. **0229201006042** of Canara Bank of India, Chembur Sindhi Society branch, on 01/10/2016 to meet grant for the project entitled "**Martian landform segmentation based on structural similarity**" during 1<sup>st</sup> year of the project.

You are requested to acknowledge immediately through FAX/e-mail followed by post. Please ignore if already acknowledged.

FAX : 080 - 2341 6770  
e-mail : [pr.aospace@isro.gov.in](mailto:pr.aospace@isro.gov.in)

You are further requested to submit Audited Statement of Accounts (Receipts & Payments) together with Fund Utilisation Certificate (format enclosed) within 12 months of the closure of the Financial year of support to the undersigned to close the advance payment in our Books of Account.

Thanking you,

Yours sincerely,

Encl : FUC format.

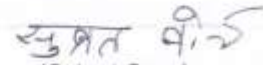
  
(Subrat Bose)  
Pay & Accounts Officer

Copy to:- 1. The Programme Director, SSO, ISRO Hq., Bengaluru.

2. Shri. Abhijit Shete, Assistant Profesesor, VES Institute of Technology,  
Collectors Colony Road, Chembur, Mumbai.



# Vivekanand Education Society's Institute of Technology

(Affiliated to University of Mumbai, Approved by AICTE & Recognized by Govt. of Maharashtra)



No.B.19013/9/2016-Sec.2  
Government of India  
Department of Space  
\*\*\*

Antariksh Bhavan,  
New BEL Road,  
Bengaluru - 560 231.

August 10, 2016

Principal,  
VES Institute of Technology,  
Collectors Colony Road,  
Chembur, Mumbai.

Sir,

Sub: **Grant-in-aid – Space Science Promotion - Release of grant for the project entitled "Martian landform segmentation based on structural similarity" - reg.**  
\*\*\*

I am directed to convey the sanction of the President to a grant of ₹1,10,000/- (Rupees One lakh and ten thousand only) to meet the expenditure towards the project entitled "**Martian landform segmentation based on structural similarity**" (total project cost of ₹3.08 lakhs for a period of 3 years) by VES Institute of Technology during first year of the project.

2. The amount of ₹1,10,000/- (Rupees One lakh and ten thousand only) will be paid to you by the Pay & Accounts Officer, Department of Space, Antariksh Bhavan, New BEL Road, Bengaluru - 560 231 on receipt of the bill.
3. The grant-in-aid sanctioned shall be subject to the terms and conditions mentioned in the Annexure enclosed.
4. A separate account for the grant-in-aid sanctioned will have to be maintained which are subject to the scrutiny by the Indian Audit and Accounts Department who will also have the right of access to the Book of Accounts.
5. Accounts of expenses incurred out of grant should be prepared, maintained and authenticated by approved auditors. The final accounts statement in duplicate duly audited should be sent to the Pay & Accounts Officer, Department of Space, Bengaluru-560 231 at the end of each financial year of support.

...2/-



# Vivekanand Education Society's Institute of Technology

(Affiliated to University of Mumbai, Approved by AICTE & Recognized by Govt. of Maharashtra)

- 2 -

6. The expenditure involved is debitable to "Head:3402.00.103.20.00.31- Space Resarch- Space Sciences-Space Science Promotion- GIA-General" Under Grant No.84, "Department of Space" for the FY 2016-17.

Yours faithfully,

(Poojima M)  
Sr.Accounts Officer

Copy for information and necessary action to:

1. The Scientific Secretary, ISRO, Bengaluru
2. The Programme Director, SSO, ISRO Hq., Bengaluru
3. The Principal Director of Audit, Scientific Departments, DGACR Building, IP Estate, New Delhi
4. The Director of Audit, Office of the Principal Director of Audit, Scientific Departments, Antariksh Bhavan, New BEL Road, Bengaluru - 560 231
5. Chief Controller of Accounts, DOS, Bengaluru
6. Senior Accounts Officer, ISRO Hq., Bengaluru
7. The Pay & Accounts Officer, Department of Space, Bengaluru - With a request to make the payment of ₹1,10,000/- (Rupees One lakh and ten thousand only) in favour of "The Principal, VES Institute of Technology, Mumbai" on receipt of the bill
8. The Senior Head (Internal Audit), DOS, Bengaluru
9. Shri. Abhijit Sharad Shete, Assistant Professor, VES Institute of Technology, Collectors Colony Road, Chembur, Mumbai.

(Poojima M)  
Sr.Accounts Officer



Government of India  
Department of Space

13

## Terms and conditions of ISRO Research Grants

1. The approved funds should be utilised solely for the purposes for which they have been granted unless ISRO agrees otherwise. A certification that the funds have been so used should be produced by the grantee institution after the end of each year of the support.
2. Due acknowledgement to ISRO should be made in all reports and publications arising out of the part of the work supported by ISRO. The grantee will take prior permission of ISRO before publishing any work based on the ISRO supported project.
3. Two copies of all the publications resulting from the research conducted with the aid of the grant should be submitted to ISRO.
4. No investigator receiving a grant from ISRO may make commercial use of the results of his work by patent or otherwise. ISRO reserves the exclusive right to determine whether any patent shall be taken out and what commercial use, if any, shall be made of any result of the investigations. The patents shall be in the name of ISRO and ISRO shall retain exclusive rights to commercially exploit them. The shares, if any, of the royalty to the investigator, the parent institution and ISRO, will be determined by ISRO.
5. The Principal Investigator is required to submit two copies of yearly reports indicating the progress of the work accomplished. He is also required to submit two copies of a detailed technical report on the results of the research/development after the completion of the project. The reports will become the property of ISRO.
6. In addition, ISRO may designate scientists/specialists to visit the institution periodically, for reviewing the progress of the work.
7. An inventory of items purchased from ISRO funds should be sent to ISRO, giving the description of equipment, cost in rupees, date of purchase and name of the supplier along with a purchase certificate from the Administration of the Institution. All items of equipment and unconsumable items costing more than Rs.5,000/- shall remain the property of ISRO and ISRO reserves the right to transfer them or dispose of them on the termination of the project as ISRO may deem fit.
8. The accounts of the expenses incurred out of ISRO funds should be properly maintained and should be authenticated by an approved auditor. The final accounts statement in duplicate duly audited should be sent to the Pay & Accounts Officer, DOS/Senior Accounts Officer, ISRO Headquarters, as the case may be, at the end of each financial year of support.
9. If the total amount sanctioned is not spent during the period of support, the remainder amount should be surrendered to the Pay & Accounts Officer, DOS/Senior Accounts Officer, ISRO Headquarters, as the case may be, within one month after the completion of the project.
10. The assets acquired wholly or substantially out of the ISRO grant should not, without its prior sanction, be disposed off, encumbered or utilised for purposes other than that for which the grant is sanctioned.
11. A register of Assets, permanent and semi-permanent, should be maintained by the grantee institution, which should be available for scrutiny by Audit.
12. The grantee institution should not divert the grants-in-aid for utilisation of the same for similar objects of another institution if it is not in a position to execute or complete the assignment. The entire amount of the grant should then be immediately refunded to ISRO by the institution.
13. The terms and conditions of ISRO research grants are subject to change from time to time, but the funding of any project will be governed by the terms and conditions existing on the date of starting of the project with ISRO funds.



# Vivekanand Education Society's Institute of Technology

(Affiliated to University of Mumbai, Approved by AICTE & Recognized by Govt. of Maharashtra)



Lifna C S <lifna.cs@ves.ac.in>

## Fwd: Welcome to the AI for Earth Community

1 message

Priya R L <priya.rl@ves.ac.in>

Sat, Nov 2, 2019 at 10:04 AM

To: Lifna C S <lifna.cs@ves.ac.in>, Sharmila Sengupta <sharmila.sengupta@ves.ac.in>

Mrs. Priya R. L  
Assistant Professor  
Department of Computer Engineering  
VES Institute of Technology  
Chembur, Mumbai.

----- Forwarded message -----

From: **AI for Earth Grant Support** <ai4ehelp@microsoft.com>  
Date: Sat, Nov 2, 2019 at 3:45 AM  
Subject: Welcome to the AI for Earth Community  
To: priya.rl@ves.ac.in <priya.rl@ves.ac.in>



Dear Priya R.L,

Congratulations, and welcome to the AI for Earth community! We are excited to share that your application for the project titled "Predictive analysis of carbon footprint in metropolitan cities of India," has been selected for an AI for Earth Microsoft Azure Compute Grant. Through this award, you will receive a sponsored Microsoft Azure account. We are granting you credits for Azure consumption up to \$10000 USD, to be utilized within one year.

By accepting this award, you agree to the following terms:

- You will submit a mid-term report and a final report according to AI for Earth guidelines
- Microsoft may use materials (or summaries of those materials) that you submit as part of the application, mid-term report, and final report for public communications, including Microsoft websites (including use of your organization's trademarks and logos)
- Microsoft may contact you and your team members for additional information on your project

**Please accept this award by November 7, 5pm PST through this link.** We will respond on November 8th with next steps to access your sponsored Azure credits and education resources.



# Vivekanand Education Society's Institute of Technology

(Affiliated to University of Mumbai, Approved by AICTE & Recognized by Govt. of Maharashtra)



Lifna C S <lifna.cs@ves.ac.in>

## Fwd: Welcome to the AI for Earth Community

2 messages

Abha Tewari <abha.tewari@ves.ac.in>  
To: Lifna C S <lifna.cs@ves.ac.in>  
Cc: Nupur Giri <nupur.giri@ves.ac.in>

Tue, Nov 5, 2019 at 9:37 AM

Hello mam  
Please find attached "AI for Earth " report

From: **AI for Earth Grant Support** <ai4ehelp@microsoft.com>  
Date: Sat, 2 Nov 2019, 06:56  
Subject: Welcome to the AI for Earth Community  
To: 2017.varad.kshemkalyani@ves.ac.in <2017.varad.kshemkalyani@ves.ac.in>

cid:image001.png@01D590D6.93A087B0

Dear Varad Kshemkalyani,

Congratulations, and welcome to the AI for Earth community! We are excited to share that your application for the project titled "Predicting floods in coastal regions as a direct consequence of deforestation" has been selected for an AI for Earth Microsoft Azure Compute Grant. Through this award, you will receive a sponsored Microsoft Azure account. We are granting you credits for Azure consumption up to \$10000 USD, to be utilized within one year.

By accepting this award, you agree to the following terms:

- You will submit a mid-term report and a final report according to AI for Earth guidelines
- Microsoft may use materials (or summaries of those materials) that you submit as part of the application, mid-term report, and final report for public communications, including Microsoft websites (including use of your organization's trademarks and logos)
- Microsoft may contact you and your team members for additional information on your project

**Please accept this award by November 7, 5pm PST through this link.** We will respond on November 8th with next steps to access your sponsored Azure credits and education resources.

Bonnie Lei

AI for Earth Project Manager  
Environmental Sustainability

Microsoft respects your privacy. Review our online Privacy Statement

Microsoft Corporation

One Microsoft Way